

CONTENTS

OPERATOR'S MANUAL FOR M4500/ M4500DT/
M5500/ M5500DT/ M7500/ M7500DT

Part Number: 3545899715



CONTENTS

SERVICING OF TRACTOR

SAFETY PRECAUTIONS

INSTRUMENTS AND CONTROLS

OPERATION

FUEL AND LUBRICANT SPECIFICATIONS

MAINTENANCE

STORAGE

SPECIFICATIONS

WIRING DIAGRAM

FORWARD

You are now the Proud owner of a Kubota Tractor. This tractor, a product of Kubota quality engineering, is made from the finest materials under a rigid quality control system and will give you long, reliable service. Careful reading of this manual will insure that you get maximum performance from the tractor. This manual will familiarize you with the controls and operation of the tractors and contains many helpful maintenance and safety instructions. It is Kubota's policy to make immediate use of every advance in our research. This immediate application of new technology may cause some limited portions of this manual to be outdated. Kubota dealers and distributors will have the most up-to-date information regarding any changes made on the tractor that are not included in this manual. Please do not hesitate to consult with them.



IMPORTANT NOTICE

This is the industry's "Safety Alert Symbol". This symbol is used to call your attention to items or operations that could be dangerous to you or other persons using this equipment. Please read these messages carefully.

It is essential that you read the instructions and safety regulations before you attempt to assemble or use this unit.

CONTENTS

Servicing of Tractor	1
Safety Precautions	2
Safety Section	3
1. Tractor operations	3
2. Handling fuel and other combustable materials	3
3. Precautions for parts of tractor	4
4. Common machinery hazards	5
5. Check points	5
Instruments and Controls	6
1. Instrument panel	7
2. Controls	8
Operation	12
1. Introduction	13
2. World wide graphic symbols	13
3. Break-in procedures	13
4. Prestarting inspection	14
5. Starting and stopping the engine	14
6. Operation the tractor	14
7. Performance checks during operation	15
8. Operating the tractor on the farm	15
9. Wheel adjustment	19
10. Fender adjustment	21
11. Weighting the tractor	21
Fuel and Lubricant Specifications	22
1. Fuels	23
2. Lubricants	23
Maintenance	26
1. Break-in procedure	27
2. Lubrication intervals during break-in period	27
3. Other checks during break-in period	27
4. Service and lubrication intervals	27
5. Periodic service procedures	27
6. Fuel system maintenance	30
7. Transmission/hydraulic system maintenance	32
8. Cooling system	33
9. Electrical system	34
10. Fan belt adjustment	37
11. Periodic service schedule	38
12. Battery trouble shooting	39
13. Engine trouble shooting	40
Storage	41
1. Tractor storage	41
2. Removing the tractor from storage	41
Specifications	42
1. Specifications	43
2. Tractor speed	45
Wiring diagram	46

SERVICING OF TRACTOR

Your KUBOTA Dealer is interested in you and your new tractor. Your dealer is a skilled and knowledgeable professional. He has the know-how to assure that you will receive the most value from your tractor and implements.

Read this manual carefully. The manual describes the correct operating procedures for all the various tractor components and outlines all required service procedures. Upon reading the manual, you will discover that you can do most of the required servicing yourself. If you need assistance with servicing, or if you need parts see your KUBOTA Dealer. He is there to serve you.

When ordering parts, be prepared to give the dealer both the engine and tractor serial numbers.

The tractor serial number is located on the right side of the transmission case. The engine serial number is stamped on an unpainted plate on top of the fuel injection pump. The fuel injection pump is located on the right hand side of the engine.

Locate the serial numbers now and record them in the spaces provided below.



Before using implements not sold by KUBOTA DISTRIBUTOR, contact your nearest dealer, regarding safety in its application.

KUBOTA TRACTOR

Tractor Serial No. _____

Engine Serial No. _____

Date of Purchase _____

(To be filled in by purchaser)

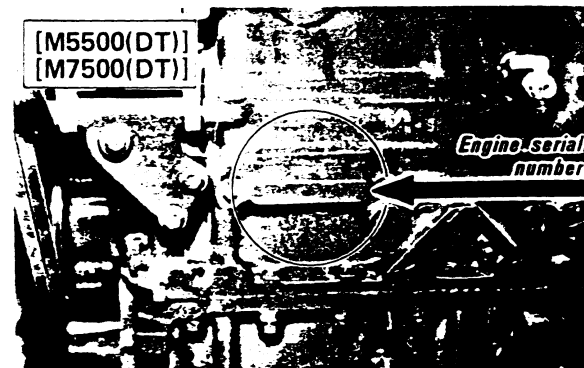
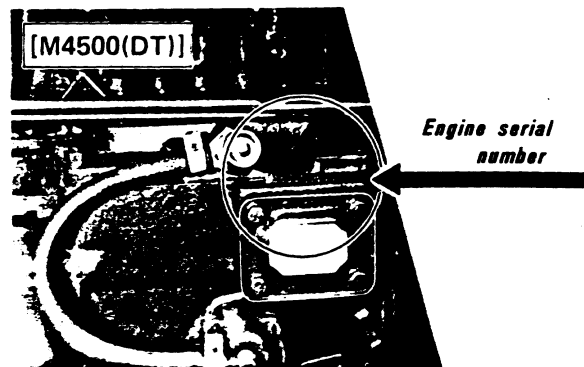
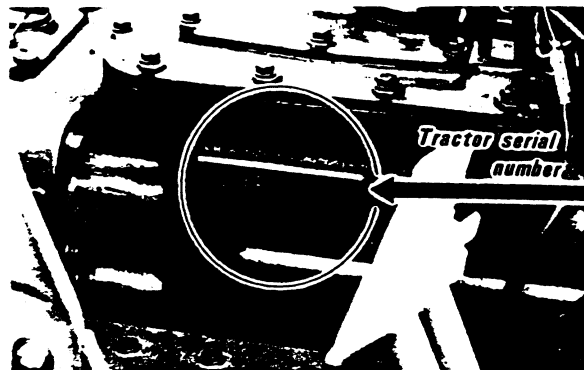
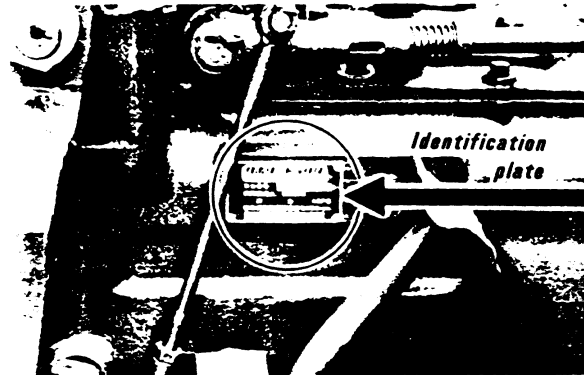



SAFETY PRECAUTIONS

- 1. TRACTOR OPERATIONS**
- 2. HANDLING FUEL AND OTHER COMBUSTABLE MATERIALS.....**
- 3. PRECAUTIONS FOR PARTS OF TRACTOR**
 - Radiator
 - Battery
 - Hydraulics
 - Power take-off
 - Differential lock
 - Drawbar
 - Implement safety
- 4. COMMON MACHINERY ,**
- 5. CHECK POINTS**

SAFETY PRECAUTIONS

SAFETY SECTION

While equipment safety is a uniquely human preoccupation, people operating equipment continue to be the greatest hazard to themselves. In many cases, it is the failure of human judgement that results in the most severe accidents. Carelessness, taking unsafe short cuts, ignoring warnings and operating machinery with which people are unfamiliar are most often the cause of serious accidents where people are hurt or killed.

This safety section has been prepared to provide you with information that will help you avoid unsafe operating conditions. This section of the manual is a review of general safety precautions that relate to the tractor and farm machinery in general. Before operating your tractor, read this section and the entire manual carefully. Commit the following safety precautions to memory, make them part of your everyday work habits. Be sure you understand all the operating procedures for the tractor and that you are familiar with the tractor instruments and operating mechanisms before you operate the tractor.

Once you have familiarized yourself with the tractor and its operating characteristics, be aware that this familiarity can cause carelessness. Familiarity with your tractor does not mean that safety can be forgotten. A renewed commitment to safety must be made every day. Remember, **SAFETY IS NO ACCIDENT !**

1. TRACTOR OPERATIONS

This section contains general tractor operating safety suggestions as well as specific suggestions for safe maintenance and operation of various tractor components.

- (1) Do not start the tractor unless you are seated in the driver's seat.
- (2) Do not allow anyone, other than the driver, to ride on the tractor, drawbar or three point hitch at any time.
- (3) When operating the tractor on public roads, obey all traffic laws and local regulations pertaining to the operation of farm equipment.
- (4) Lock the brake pedals together whenever operating the tractor on the road. Uneven braking at road speed may cause the tractor to swerve uncontrollably.
- (5) Exercise extreme caution when operating the tractor up and down or across hillsides. Before starting hillside operation, widen the wheels to the widest position. Keep the brake pedals locked together and the tractor in gear. Avoid sharp turns or sudden movement with the tractor. Always carry any attached implements low. Never allow the tractor to freewheel downhill.
- (6) Keep a safe distance between the tractor and the edge of cliffs, gullies and ditches. The shoulders of such drop-offs may be soft and give way under the weight of the tractor wheel allowing the tractor to tip or fall.
- (7) Do not tow the tractor at a speed greater than it would travel under its own power.
- (8) Never tow a trailer that weighs more than twice the weight of the tractor unless the trailer is equipped with brakes.
- (9) Exercise extreme caution when pulling heavy loads at road speed. Avoid sudden application of the brakes. When travelling downhill, keep the tractor in low gear in order to maintain control without overworking the brakes.
- (10) Always wear appropriate personal protective equipment such as eye protection, ear plugs, head protection, gloves, steel-toed shoes, air filtration equipment or other kinds of body protection that may be appropriate for the kind of work you are doing. Be aware that loose fitting clothing can get caught in moving parts which may result in personal injury.
- (11) When working with crop chemicals, protect your eyes, skin and respiratory system from damaging contact with the chemicals.
- (12) Do not operate your tractor with worn-out, obsolete equipment or equipment that is incompatible with the tractor.
- (13) Do not perform maintenance or repairs to the tractor or other machinery if you are not qualified to do so. A machine that is not repaired properly may be unsafe to operate. If, at any time, you have any question about the repair and maintenance procedures for your KUBOTA Tractor, see your KUBOTA Dealer.
- (14) Do not perform any maintenance work to the tractor or attached implements while they are in motion unless such repair is specifically recommended by the manufacturer.
- (15) While operating the tractor always be aware of any noticeable changes in the operating characteristics of the tractor, including changes in the color of the engine exhaust and unusual sounds or vibrations. Unusual operating characteristics often warn of a more serious underlying problem that may not only endanger the operator's safety, but may indicate a serious mechanical malfunction.
- (16) NEVER OPERATE THE TRACTOR OR ANY AGRICULTURAL EQUIPMENT WHILE UNDER THE INFLUENCE OF ALCOHOL OR OTHER DRUGS.
- (17) Keep a fire extinguisher near your fuel filling and fuel storage areas. Be sure the extinguisher is properly maintained and that you are familiar with its use.
- (18) Keep a first aid kit in a convenient location.

2. HANDLING FUEL AND OTHER COMBUSTABLE MATERIALS

- (1) Store fuel in a well-ventilated area.
- (2) Never refuel the tractor while the engine is running or while the engine is hot.
- (3) Do not smoke, light matches or expose open flame while using starting fluid, filling the fuel tank, or servicing the fuel system.

- (4) Wipe up any spilled fuel after you have filled the tractor fuel tank.

3. PRECAUTIONS FOR PARTS OF TRACTOR

■ Radiator

- (1) Do not open the radiator cap while the engine is hot. The tractor has a pressurized cooling system. Boiling water may gush out when the cap is removed.
- (2) Add coolant to the radiator only when the engine is stopped or while it is idling. To avoid being scalded when the pressure cap is removed, turn the cap slightly to release pressure before opening the cap all the way.
- (3) Do not pour cold water into an overheated engine. The cylinder block may crack.
- (4) Keep the radiator screen clean and free of debris.

■ Battery

- (1) Disconnect the ground cable from the battery before making adjustments or repairs to the tractor electrical system.
- (2) Avoid making sparks or exposing open flame around the battery. If battery charging is required, turn off the battery charger before connecting and disconnecting the charger from the tractor battery.
- (3) Before using a jumper or booster battery read the instruction in the electrical service section of this manual.
- (4) Handle electrolyte with care. Keep electrolyte away from bare skin and eyes and clothing.
- (5) When disconnecting the battery cable, disconnect the negative (-) cable first. When connecting the battery cables, connect the positive (+) cable first.

■ Hydraulics

- (1) The hydraulic system operates by pumping oil at extreme pressure. If a leak develops in a hydraulic line it may be almost invisible. If you suspect that there is a hydraulic leak in a line or fitting, do not place your hand or arm near the suspected leak. Use a piece of cardboard or wood held near the suspected leak to show the exact location of the leak. Hydraulic fluid is pumped at sufficient pressure to penetrate the skin and enter the blood stream causing serious personal injury. If you suspect you have been injured by escaping hydraulic fluid, see a doctor at once.
- (2) Before disconnecting any hydraulic lines, turn the engine off and where possible relieve hydraulic pressure.
- (3) If repairs have been made to the tractor hydraulic system, check all fittings, lines, and hoses for damage before starting the tractor. Once the tractor is started, make a careful and complete visual inspection of all hoses and fittings looking for leaks that may have developed as the system was operated under pressure. If any leaks are discovered, make necessary repairs immediately.

■ Power take-off

- (1) Before disconnecting an implement PTO shaft from the tractor PTO shaft be sure the engine is off, the PTO clutch is disengaged or the PTO gearbox is in neutral and that the PTO shaft has stopped turning.
- (2) Keep all PTO shields in place whenever the PTO shaft is being used. When the PTO shaft is not being operated, replace the tractor PTO shaft cover. This cover will prevent injury and help keep the shaft clean.

■ Differential lock

- (1) Read the differential lock operating instructions before using the differential lock.
- (2) Do not attempt to turn the tractor with the differential lock engaged.
- (3) Do not operate the differential lock while operating the tractor on the road.

■ Drawbar

- (1) All pulling or towing, other than that done with three point hitch mounted implements, should be done from the drawbar. **DO NOT ATTACH ANY IMPLEMENT, PULL-CHAIN OR ROPE TO ANY POINT ON THE TRACTOR ABOVE THE CENTER LINE OF THE REAR AXLE.**
- (2) When attaching drawn equipment to the drawbar, back the tractor up so the implement attaching hole is past the drawbar mounting hole. The holes may then be lined up as the tractor moves forward away from the implement.
- (3) Whenever possible, heavy loads should be hitched directly to the drawbar. If it becomes necessary to use a chain to pull a heavy load, take up slack in the chain slowly.

■ Implement safety

When installing or using the implement, be sure to read the instruction for the implement and keep the precautions in mind.

- (1) Use front counterweights of appropriate weight whenever operating the tractor with a three point hitch mounted implement.
- (2) Whenever attaching a three point PTO driven implement to the tractor, turn off the engine and set the parking brake before attaching the PTO shaft to the tractor.
- (3) Use the three point hitch lock to hold the three point hitch in the raised position when transporting a mounted implement over the road.
- (4) When mounting or dismounting an implement to or from the three point hitch, do not stand between the implement and the tractor.
- (5) If the tractor is operated with a front loader, be sure there is sufficient counter weight on the rear wheels to offset the weight of the loader. An under weighted rear axle will result in loss of traction when the loader bucket is loaded.

SAFETY PRECAUTIONS

4. COMMON MACHINERY HAZARDS

■ Whenever you are operating any type of farm equipment including your KUBOTA Tractor, you should be aware of certain kinds of common machinery hazards. These include:

- (1) PINCH POINTS. Machinery components that can come together and compress or pinch.
- (2) WRAP POINTS. As on the end of an exposed shaft or the middle of an exposed PTO shaft. Wrap points are particularly dangerous when operating equipment while wearing loose fitting clothing.
- (3) SHEAR POINTS. When operating machinery equipped with blades, hydraulic cylinders and other moving parts, be aware of shear points, places where two machinery components come together in such a way that they can cut or shear.
- (4) CRUSH POINTS. Crush points are sometimes the most difficult to detect. Crush points include tires and wheels but may also include, for example, the area between two movable pieces of machinery, or the space under a piece of machinery that has been jacked up or is resting on blocks and that may not be secure. Other common hazards include freewheeling parts such as inertia wheels or fly wheels, thrown objects, store energy (such as in compressed springs) and second party accidents involving other people.

5. CHECK POINTS

■ Always check the following before operating the tractor:

- (1) TIRE PRESSURE. If the tires are low, inflate them to the correct pressure.
- (2) PROTECTIVE SHIELDS. Be sure all protective shields are in place and secured.
- (3) STEPS AND PLATFORMS. Check the tractor mounting steps and step plates. Be sure they are secure and free of mud, oil or other slippery material.
- (4) ROPS AND SEAT BELTS. If the tractor is equipped with a ROPS and seat belts, be sure the ROPS mounting bolts are tight. Check the seat belt for signs of wear that could effect its integrity under stress. Be sure the seat belt is securely fastened to the tractor.
- (5) SEAT POSITION. The seat should be positioned so that the control levers and switches can be reached easily and comfortably.
- (6) INSTRUMENTS. Once the tractor has been started, check all instruments to assure they are operating correctly. Do not operate the tractor unless all instruments and warning lights are functioning.
- (7) FLUID LEAKS. Once the tractor has been started, allow it to warm up for several minutes before operating under a load. While the tractor is warming up, make a visual inspection of the machine looking for evidence of water or oil leaks.

Keeping the tractor clean and free of excess debris will make for safer operation by eliminating material that may be slippery and can hide evidence of mechanical problems. It is important that the tractor be maintained in accordance with this manual. Failure to maintain the tractor properly may create an unsafe operating situation.

MAKE ALL ADJUSTMENTS AND DO ALL SERVICE PROCEDURES AT LEAST AS OFTEN AS IS SPECIFIED IN THIS MANUAL. REMEMBER THAT THE PROCEDURES RECOMMENDED IN THIS MANUAL ARE FOR AVERAGE OPERATING CONDITIONS. YOUR OPERATING CONDITIONS MAY REQUIRE MORE FREQUENT ATTENTION TO SPECIFIC ADJUSTMENTS OR SERVICE PROCEDURES. UNDER NO CIRCUMSTANCES SHOULD MAINTENANCE INTERVALS BE EXTENDED BEYOND THOSE RECOMMENDED IN THIS MANUAL.

INSTRUMENTS AND CONTROLS

1. INSTRUMENT PANEL	7
■ Key and light switch	7
■ Starter/preheating switch	7
■ Turn signal lamp switch	7
■ Hour meter	8
■ Water thermometer	8
■ Oil pressure warning lamp (red)	8
■ Alternator warning lamp (red)	8
■ PTO clutch indicator lamp (red)	8
2. CONTROLS	8
■ Hand throttle	9
■ Engine stop knob	9
■ Brake pedals	9
■ Foot throttle pedal	9
■ Parking brake lever	9
■ Differential lock pedal	9
■ Hydraulic draft lever	9
■ Hydraulic position lever	9
■ Down speed adjusting lever	10
■ Ground PTO gear-shift lever	10
■ PTO clutch control lever	10
■ Front wheel drive lever – DT types	10
■ Main gear-shift lever	11
■ Hi-lo gear-shift lever	11
■ Creep gear-shift lever	11
■ Clutch pedal	11
■ Hydraulic auxiliary control lever	11

INSTRUMENTS AND CONTROLS

1. INSTRUMENT PANEL

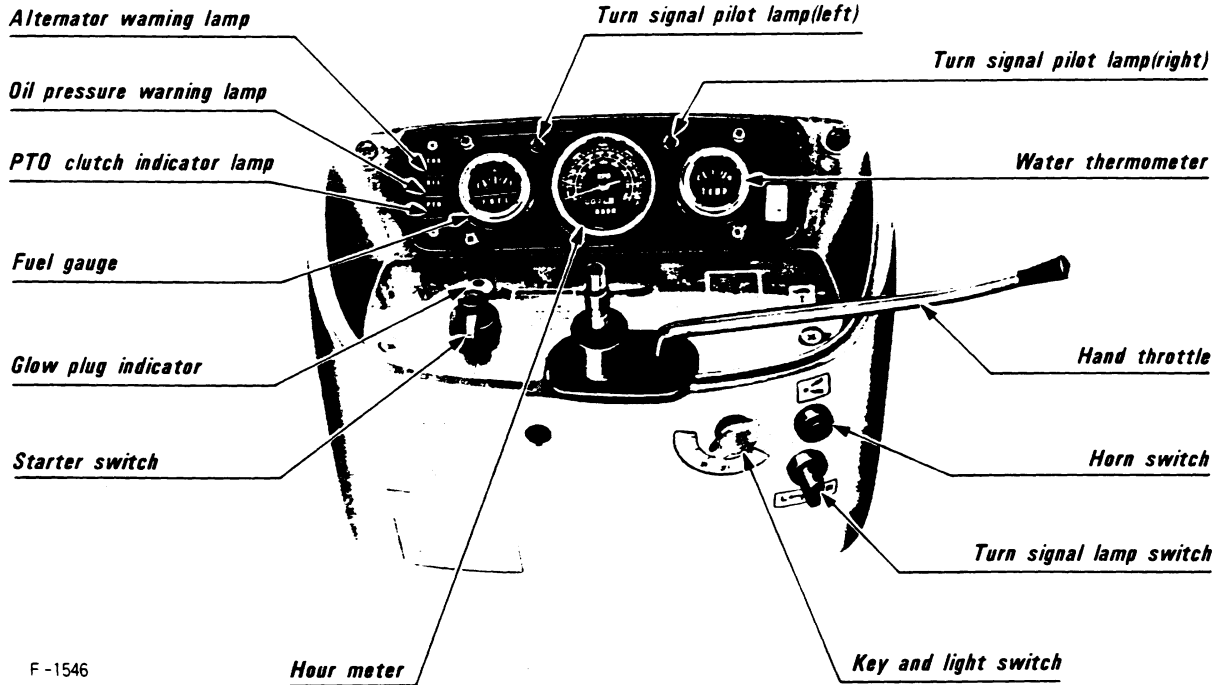

F-1546

■ Key and light switch

OFF All the circuits are open. (Key can be removed)
 ON Engine can be started. All meters and switches are turned on.

- ☾ Head lamps on, high beam.
- ☾ Head lamps dimmed, low beam.
- ☾ Clearance and tail lamps are turned on. (Key can be removed.)



Take the key out when not using the tractor.

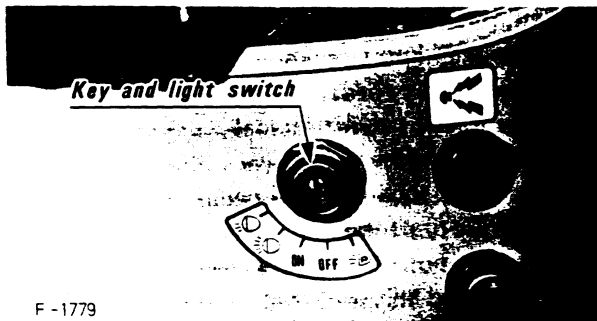

F-1779

■ Starter/preheating switch

- (1) Turn the switch to "Preheat", to preheat the combustion chamber.
- (2) To start the engine, shift the hi-lo shift-gear lever to neutral, and turn the starter switch to "Start." Take your fingers off the switch, and it will return automatically when the engine starts.

[PRECAUTION]

The engine will not start if the hi-lo gear-shift lever is not in neutral.

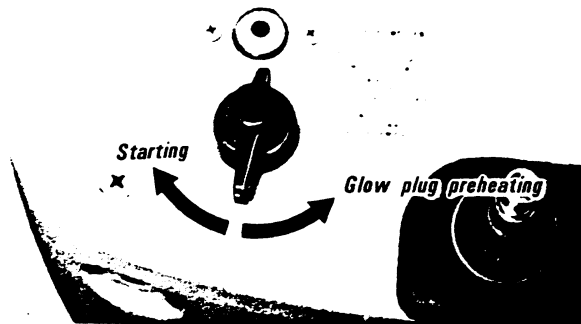

■ Turn signal lamp switch

- (1) When the switch is turned on, the turn signal lamps and their pilot lamps on the control panel will blink.
- (2) After turning, return the switch to the center.

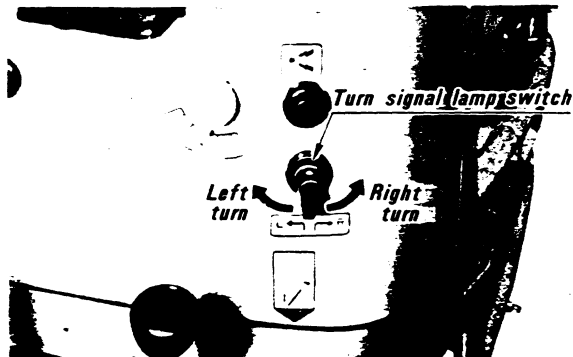

■ Hour meter

The hour meter shows the engine revolution, PTO shaft revolution and the number of hours the tractor has been used for.

- (1) The indicator shows the engine revolution and the corresponding PTO revolution. The red line indicates the standard PTO revolution.
- (2) The center of the meter has 5 digits showing the number of hours the tractor has been used (to the nearest tenth.)

■ Water thermometer

This indicates the engine temperature with the key and light switch in the ON position.

[CAUTION]

If the indicator should go over H line, the engine must be stopped until the cause of the overheating is corrected.

(Such as quantity of cooling water, fan belt loosening)

- (1) After operating the engine, never touch radiator until it has had sufficient time to cool.
- (2) Check this water thermometer frequently as you operate.

■ Oil pressure warning lamp (red)

Shows whether the oil pressure in the engine is proper.

- (1) The light goes on when the key and light switch is turned on. It goes off when the engine starts and the engine oil starts to circulate normally.
- (2) If the light stays on even after the engine starts, immediately stop the engine, and check the cause of the trouble.

It is normal for the lamp to stay on while the engine is rotating at a low speed.

■ Alternator warning lamp (red)

The pilot lamp shows whether the battery is properly charged.

- (1) The lamp goes on when the key and light switch is turned on. It goes off when the engine starts and the battery charging system starts to function normally.
- (2) If the lamp stays on even after the engine starts, immediately stop the engine, and check the regulator, fuse and relay fuse.
If the trouble cannot be located, contact your Kubota dealer.

■ PTO clutch indicator lamp (red)

The PTO clutch indicator lamp goes on when the PTO clutch is disengaged and goes off when the clutch is engaged.

2. CONTROLS

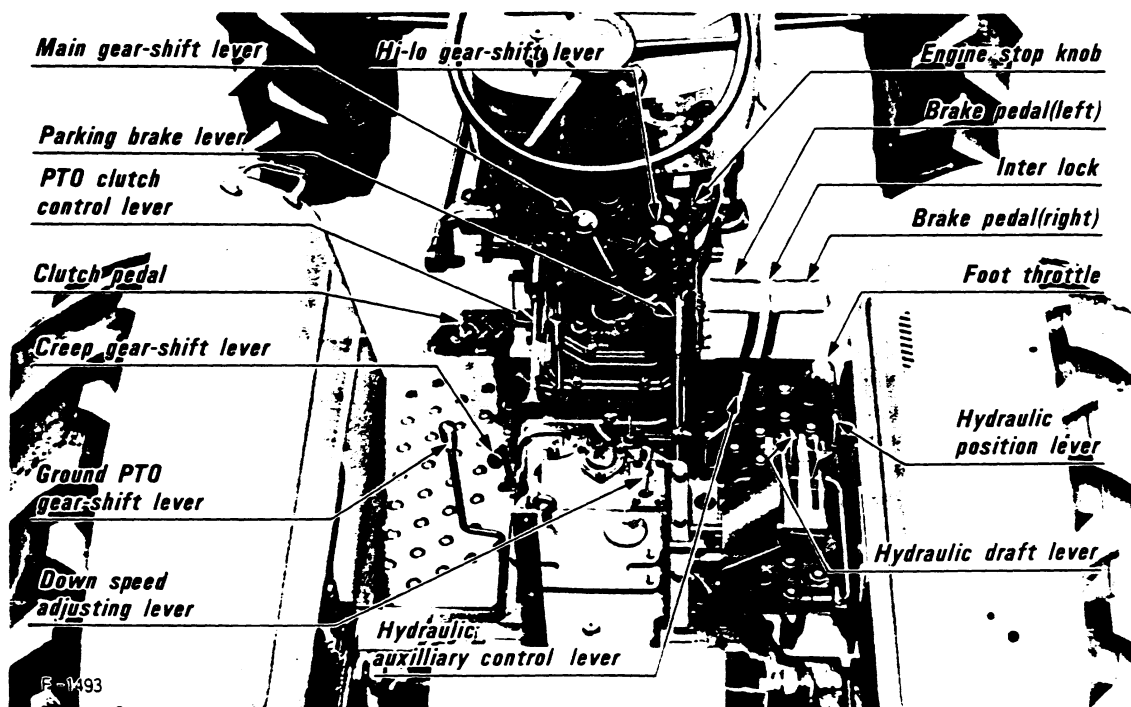
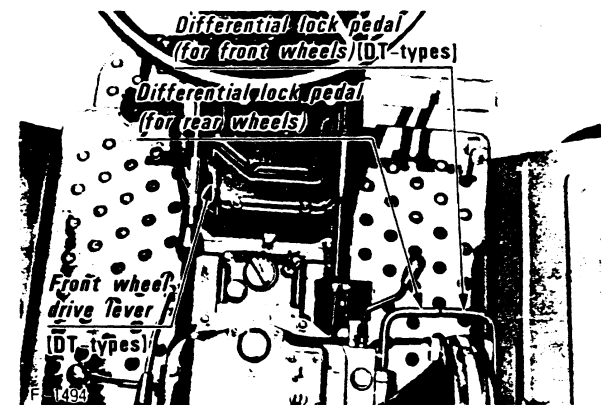

INSTRUMENTS AND CONTROLS

■ Hand throttle

Choose the engine speed most suitable for the job at hand.

- Push forward Idling
- Pushed back Maximum speed

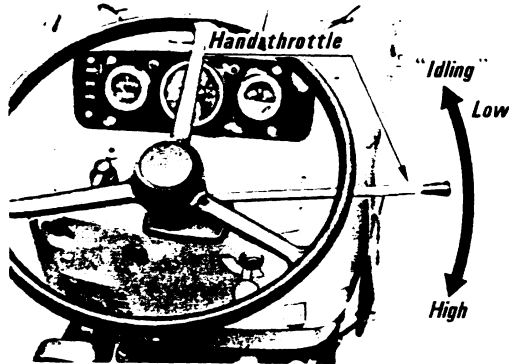

■ Engine stop knob

When the knob is pulled, the fuel supply is cut off and the engine stops.

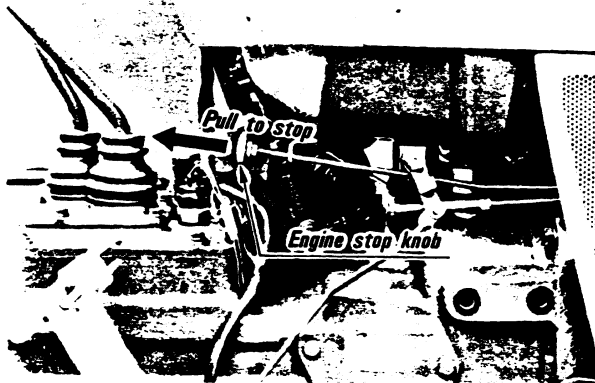

■ Brake pedals

There are two brake pedals for braking the right and left rear wheels.



When travelling on the road, use the connector to put down both brakes at the same time. Uneven braking may make dangerous sharp turns.

■ Foot throttle pedal

Use the pedal when travelling on the road. Keep your foot off the pedal while idling. Press down on it for higher speed. This pedal is interlocked with the hand accelerator lever; when using the pedal, keep the hand lever in the idling position.

■ Parking brake lever

Pull the hand brake lever to brake.

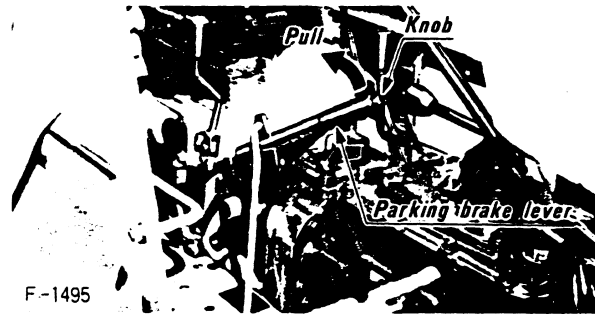

■ Differential lock pedal

If one of the rear wheels should slip, step on the differential lock pedal. Both wheels will then turn together, stopping slippage.

Differential locking is maintained only while the pedal — both pedals on DT types (4-wheel drive) — is (are) depressed.

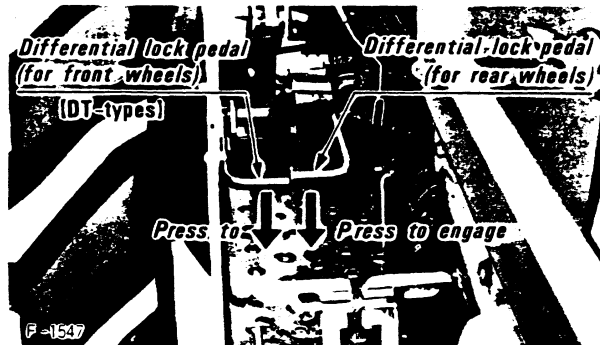

■ Hydraulic draft lever

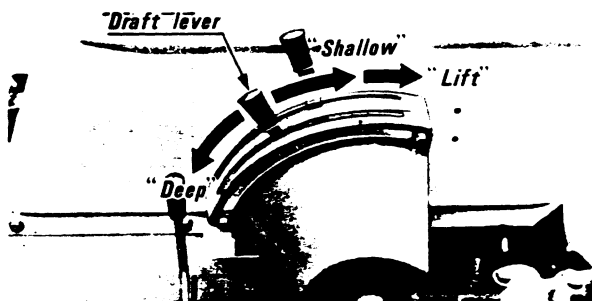

■ Hydraulic position lever

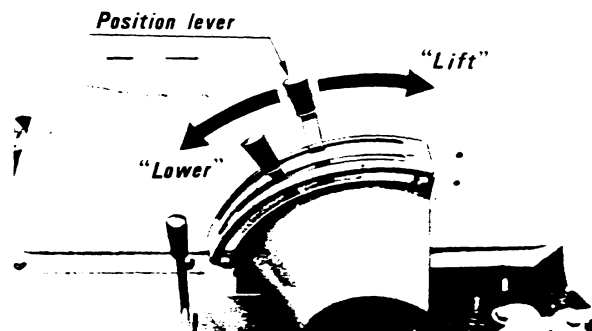

■ Down speed adjusting lever

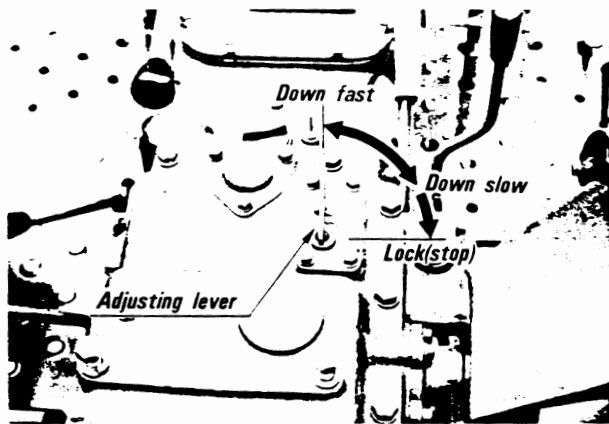

■ Ground PTO gear-shift lever

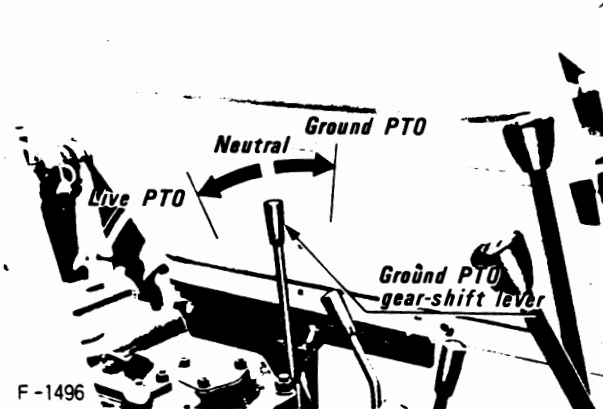

■ PTO clutch control lever

When the lever is horizontal, the PTO clutch engages. When the lever is lifted, the clutch disengages. When engaging the clutch, lower the lever while pushing it toward the fulcrum.

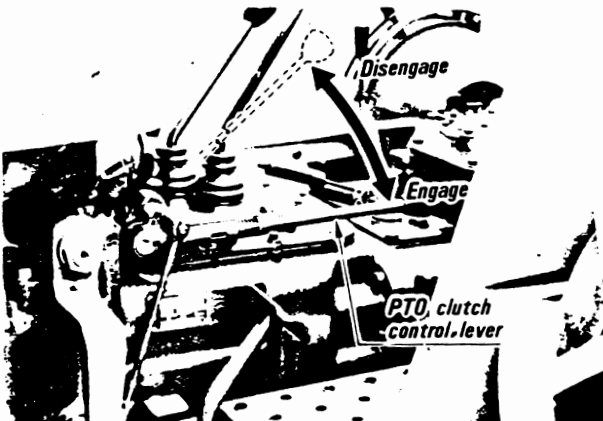

[PRECAUTIONS]

- (1) When not using the PTO shaft for long periods of time, keep the lever in the horizontal position so that the clutch is engaged.
- (2) Use the lever only when connecting or disconnecting an implement PTO shaft from the PTO shaft. Keep it in the horizontal position with the PTO pilot lamp off during operation and travelling.
- (3) To stop PTO shaft rotation, shift the ground PTO gears to neutral.



Before making adjustments of an implement, stop the engine or disengage the PTO clutch (PTO lamp turning on).

■ Front wheel drive lever – DT types (4-wheel drive)

Use the lever for driving the front wheels. Push it forward, and the front wheels will drive. Front wheel drive is effective for the following jobs:

- (1) When great pulling force is needed, such as working on a slope or in a wet field, when pulling a trailer, or when working with a front loader.
- (2) When working on sands.
- (3) When working on a hard soil where a rotary tiller might dash forward.
- (4) When entering and leaving a field or going over a bank.

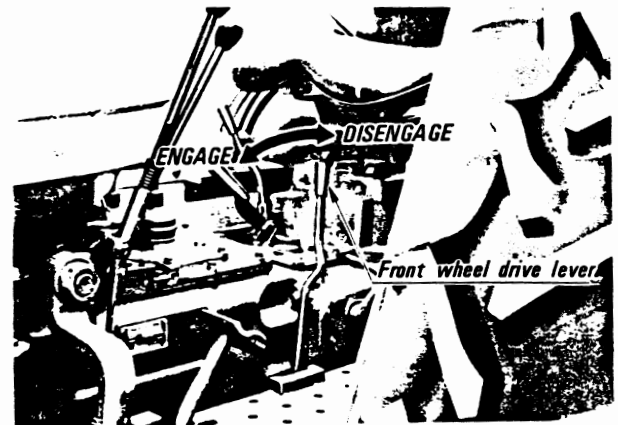

[PRECAUTIONS]

- (1) Depress the clutch pedal before engaging the front wheel drive lever.
- (2) If the front wheel drive lever is difficult to disengage, turn the steering wheel in either direction, and the lever will disengage completely.
- (3) Do not engage the front wheel drive lever while the tractor is travelling on a paved road or travelling at high speed.

Otherwise, the tires may wear down quickly. Or an accident may occur if the tractor is suddenly braked at high speed.

INSTRUMENTS AND CONTROLS

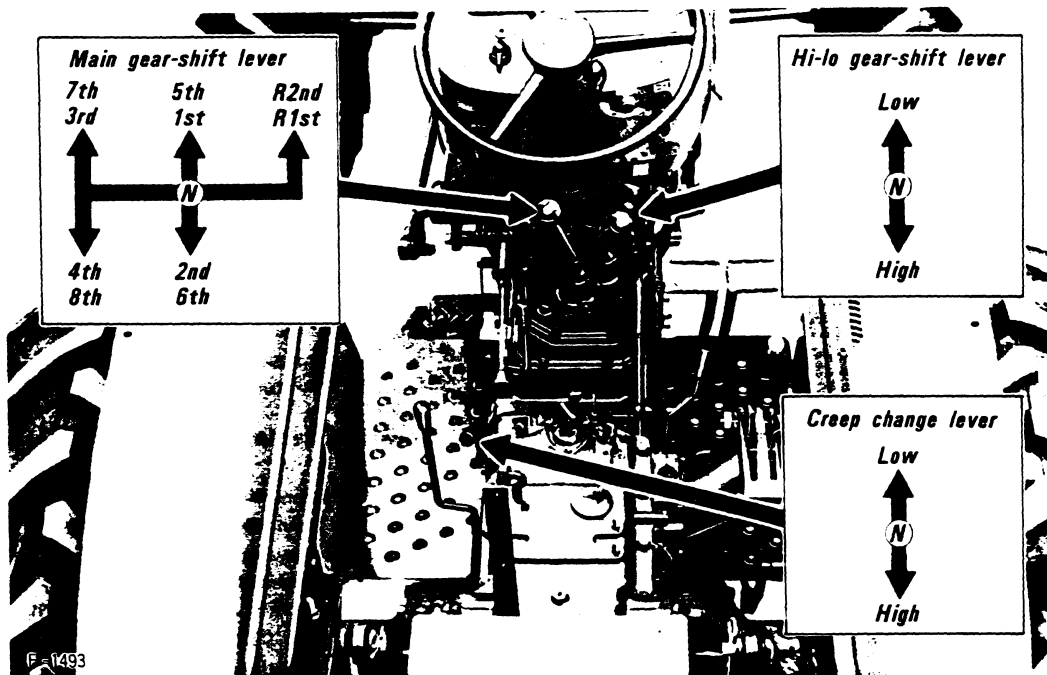

- Main gear-shift lever

- Hi-lo gear-shift lever

- Creep gear-shift lever

By using these three levers in combination, 16 forward speeds and 4 reverse speeds can be obtained.

[PRECAUTION]

Synchro-mesh is provided to all of forward gears. You can always shift the forward gear while the tractor is moving.

[M5500(DT)•M7500(DT)]

- Clutch pedal

Step on the clutch pedal quickly to disengage the clutch. Raise your foot slowly from the pedal to engage the clutch to avoid damaging the clutch plate.

- Hydraulic auxiliary control lever

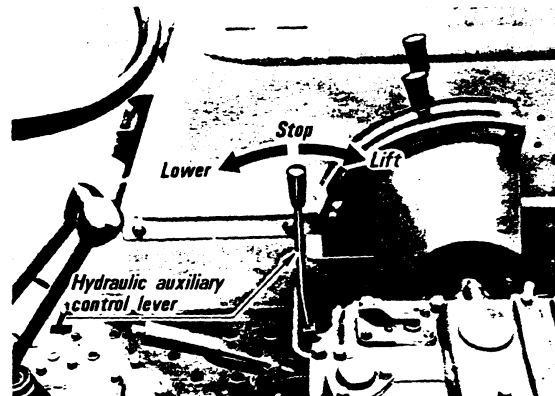

OPERATION

1. INTRODUCTION	13
2. WORLD WIDE GRAPHIC SYMBOLS	13
3. BREAK-IN PROCEDURES	13
4. PRESTARTING INSPECTION	14
5. STARTING AND STOPPING THE ENGINE	14
■ Starting	14
■ Starting the engine in cold weather	14
■ Stopping the engine	14
6. OPERATION THE TRACTOR	14
■ Starting	14
■ Stopping	14
■ Directions for use of the power steering	14
7. PERFORMANCE CHECKS DURING OPERATION ...	15
■ Oil pressure warning lamp	15
■ PTO clutch indicator lamp	15
■ Alternator warning lamp	15
■ Fuel	15
■ Exhaust fumes	15
■ Immediately stop the engine if:	15
8. OPERATING THE TRACTOR ON THE FARM	15
■ Differential lock	15
■ PTO operation	16
■ Three-point hitch	16
■ Hydraulic unit	17
■ Hitch points	17
■ Hydraulic control unit use reference chart	18
■ Drawbar	19
■ Parking the tractor	19
■ Towing the tractor	19
9. WHEEL ADJUSTMENT	19
■ Front wheels	19
■ Rear wheels (Pan type or dish type)	19
10. FENDER ADJUSTMENT	21
11. WEIGHTING THE TRACTOR	21
■ Front bumper weights	21
■ Rear wheel weights	21

OPERATION

1. INTRODUCTION











This section contains information describing the correct operating procedures for all tractor controls and operating mechanisms. Do not operate the tractor until you have read this section carefully and understand its content. If you have any questions, contact your Kubota Dealer.

Throughout this section and the rest of the manual, you will find safety suggestions. These suggestions are intended to insure that no injuries occur while the tractor or attaching implements are being used. **PAY ATTENTION TO THESE SAFETY SUGGESTIONS. SAFETY IS NO ACCIDENT.**

2. WORLD WIDE GRAPHIC SYMBOLS

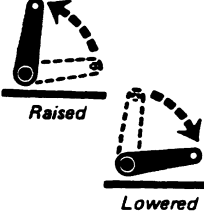
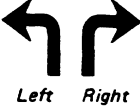
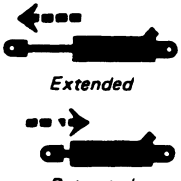
The facing page contains a chart showing worldwide graphic symbols which are used to identify operator controls on farm equipment throughout the world. Familiarize yourself with these symbols, many of which are used on the tractor to identify the instruments and controls.

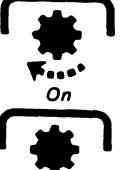
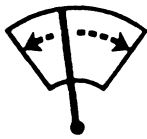
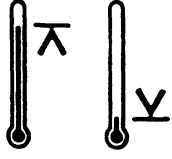
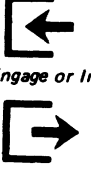
WORLD WIDE GRAPHIC SYMBOLS

 Engine Oil Pressure	 Water Temperature	 Ammeter or Generator Light	 Fuel	 Fast Slow Speed Range
 Engine R.P.M.	 Raised Lowered Rockshaft	 Left Right Turn Signals	 Extended Retracted Remote Cylinder	 Control Lever Operating Direction
 On Off Power Take-off	 Windshield Wiper	 Heating Cooling Temperature Control	 Engage or In Disengage or Out Connection	 Fuel Shut-off

3. BREAK-IN PROCEDURES

While the tractor is new, during the first 60 hours of operation, observe the following break-in procedures. Adherence to these procedures will insure longer equipment life.

- (1) Allow at least five minutes for engine warm-up before operating the tractor under a load.
- (2) Do not operate the tractor at full throttle during the break-in period.
- (3) Do not drive the tractor at high speeds.
- (4) Avoid sudden starting and stopping.

- (5) Change the engine oil and clean the oil filter 35 hours after first use. [M4500 (DT)]
- (6) Change the engine oil and clean the oil filter 60 hours after first use. [M5500 (DT) - M7500 (DT)]
- (7) Change transmission oil, and clean hydraulic oil filter 60 hours after first use.
- (8) Change front axle case oil, front differential gear case oil and front bevel gear case oil 60 hours after first use. [DT-types]

4. PRESTARTING INSPECTION

Prior to starting the engine, always inspect the tractor (see Maintenance or the Lubrication and Service Time Chart).

5. STARTING AND STOPPING THE ENGINE

■ Starting

- (1) Always shift the hi-lo gear shift lever to neutral. Otherwise, the safety starter switch will not let the engine start.
- (2) Pull the handle throttle halfway out.
- (3) Insert the key into the key and light switch, and turn it to "On".
- (4) Turn the starter switch to "Start." Release the switch as soon as the engine starts.

[PRECAUTION]

The starter switch can be turned only when the key and light switch is set to "ON" "⊙" "⊙".



Do not start the engine indoors with poor ventilation. Exhaust fumes may cause gas poisoning.

■ Starting the engine in cold weather

In cold weather, start the engine as explained below.

- (1) Follow steps (1) to (3) above.
- (2) Turn the starter switch to "Preheat" and warm the engine for 40 seconds.
- (3) While depressing the engine stop knob, turn the starter switch to "Start," and the engine will start. If it should fail to start, repeat steps (2) and (3).

[PRECAUTIONS]

- (1) If the temperature drops below 5°F, turn the starter switch to "Preheat" and warm the engine for 60 seconds, before turning the switch to "Start." If the engine does not start 5 to 10 seconds after the switch is turned to "Start," continue this until the engine starts. To protect the battery and the starter, do not leave the starter switch in "Start" position for 30 seconds or more.
- (2) Do not use starting fluid to prevent the serious trouble of engine.

■ Stopping the engine

- (1) After slowing down the engine, pull back the engine stop knob until the engine comes to a complete halt.
- (2) When the engine stops, turn the key and light switch to "Off" to prevent the battery from discharging. To keep the parking lamps on, turn the key and light switch to "⊙" and remove the key.

[CAUTION]

Push the engine stop knob back into its original position after the engine has completely stopped. If the knob is out, the engine cannot be started next time.

6. OPERATION THE TRACTOR

■ Starting

- (1) Depress the clutch pedal, and shift the main, hi-lo and creep gear levers to the desired speed.
- (2) Accelerate the engine to a proper level.
- (3) Lower the hand brake and slowly release the clutch.

[PRECAUTION]

- (1) Do not start the tractor with the parking brake on. Trouble may occur.



- (1) Sudden release of the clutch may make the tractor dash forward.
- (2) Always interlock the right and left brake pedals before travelling on public roads. Uneven braking may result in sharp turns, dangerously tilting the tractor.
- (3) Do not take any passengers on the tractor.
- (4) Do not drive the tractor close to the edges of ditches or banks which may break under the weight of the tractor, especially when the ground is loose or wet.

■ Stopping

- (1) Slow down the engine.
- (2) Step on the clutch and brake pedal.
- (3) After the tractor has stopped, shift the main, hi-lo and creep gears to neutral, release the clutch pedal, pull the hand brake and apply the parking brake.



- (1) Always apply the parking brake when parking the tractor. As this tractor has a constant-mesh transmission mechanism, it may move when the creep gear-shift lever is in "L" or "H", or the hi-lo gear-shift lever is in "Low". This normally happens when (1) the temperature of the transmission oil is high, and (2) the engine revolves at high speeds.
- (2) When parking on a slope, put blocks behind wheels, and put on the parking brake.

■ Directions for use of the power steering

- (1) Power steering is activated only while the engine is running. Slow engine speeds make the steering wheel a little heavy to handle. While the engine is stopped, the tractor functions in the same manner as other ones without power steering.
- (2) When the steering wheel is turned all the way, the relief valve opens and an alarm is produced. Do not drive the tractor with the alarm on for a long time.
- (3) Avoid turning the steering wheel while the tractor is stopped, or tires and rims may wear out sooner.
- (4) The power steering mechanism makes the steering wheel very easy to handle. Be careful when driving on a road.

OPERATION

7. PERFORMANCE CHECKS DURING OPERATION

While operating your tractor check the following regularly:

- (1) **WATER TEMPERATURE.** If engine temperature gauge needle moves past the H on the gauge, stop the engine and check the following:
- Radiator Coolant level
 - The radiator net for clogging due to a build-up of dirt and debris
 - Fan belt tension



[CAUTION]

DO NOT REMOVE THE RADIATOR CAP FOR AT LEAST TEN MINUTES AFTER THE ENGINE HAS STOPPED.

- (2) **OIL PRESSURE.** If the oil pressure lamp begins to glow while the engine is running, turn the engine off immediately. This lamp indicates low engine oil pressure. Check the following:
- Engine oil level
 - Engine oil lubrication system including the oil pump and oil filtration system.

[CAUTION]

UNDER NO CIRCUMSTANCES SHOULD THE ENGINE BE RUN WHILE THE OIL PRESSURE LIGHT IS GLOWING. IF YOU CANNOT DETERMINE THE CAUSE OF A LOW OIL PRESSURE SITUATION, CONSULT YOUR KUBOTA DEALER.

■ Oil pressure warning lamp

The oil pressure pilot lamp goes on if the oil pressure in the engine goes below the prescribed level. If this should happen during operation, and it does not go off even if the engine is accelerated to more than 1000 rpm (16.7r/s), immediately stop the engine, and check:

- (1) The quantity of engine oil (see page 23, 29 Engine oil).
- (2) The lubrication system (see page 29 Engine oil filter).

■ PTO clutch indicator lamp

- (1) The pilot lamp goes on to show that the PTO clutch lever is in the off position.
- (2) The longer the lamp is on, the heavier the load on the clutch spring, clutch bearing and engine. Avoid keeping the PTO clutch lever in the off position for longer than five minutes.
- (3) When the PTO shaft is not in use, for example, while travelling, put the PTO control lever into neutral and the PTO clutch lever in the horizontal position to stop the PTO shaft rotation.

■ Alternator warning lamp

This lamp will light if the battery is discharging. If the light should glow while the tractor is running, turn the engine off and check the battery terminals and alternator connections for loose wires.

FUELS. Check the fuel level. If the tractor runs out of fuel, the fuel system must be bled. (See Maintenance section for bleeding instructions.)

■ Fuel

Be careful not to empty the fuel tank. Otherwise air may enter the fuel system. Should this happen, the system should be bled (see page 30 Fuel system maintenance).

■ Exhaust fumes

- (1) Exhaust fumes at normal output are colorless.
- (2) Exhaust fumes become a little colored when output is increased above the prescribed level, but does not affect tractor power. Excessively dark fumes, however, may indicate trouble.

■ Immediately stop the engine if:

- (1) The engine suddenly slows down or accelerates,
- (2) Unusual noises suddenly appear,
- (3) Exhaust fumes suddenly become very dark,
- (4) The oil pressure pilot lamp goes on during operation.

[NOTE]

For checking and servicing of your tractor, contact your nearest Kubota dealer for instructions.

8. OPERATING THE TRACTOR ON THE FARM



- (1) The tractor easily tips over when working on a slope. Carefully balance the tractor.
- (2) Keep people away from the tractor during operation.
- (3) When driving into a field with very high banks, always use a ramp board to avoid tipping the tractor over.

■ Differential lock

Though very useful when used properly, the differential lock is very dangerous if misused, and may cause breakdown. Use the differential lock in the following cases:

- (1) If one wheel slips and the tractor cannot go straight up or down a slope.
- (2) If one wheel is caught in mud and the tractor cannot go forward.
- (3) If the wheels slip during plowing operation.

[PRECAUTIONS]

- (1) When using the differential lock, always slow down the engine.
- (2) The differential lock automatically releases when the pedal is released. If this does not happen, lightly step on the brake pedals alternately.



Always disengage the differential lock before turning the tractor. It is very dangerous not to do so.

■ PTO operation

By maneuvering the ground PTO gear-shift lever it is possible to select the engine drive (live PTO) or ground drive (ground PTO).

(1) LIVE PTO

Raise the PTO clutch control lever to disengage the clutch. Wait for a few seconds, and then put the ground PTO gear-shift lever into the live PTO position. PTO operation can be done completely independently of travelling. Thus the tractor can be stopped without interrupting PTO operation.

(2) GROUND PTO

Stop the tractor, and put the ground PTO gear-shift lever into the ground PTO position.

[PRECAUTION]

Do not employ the ground PTO for heavy-duty operations such as rotary tilling and forage harvesting.

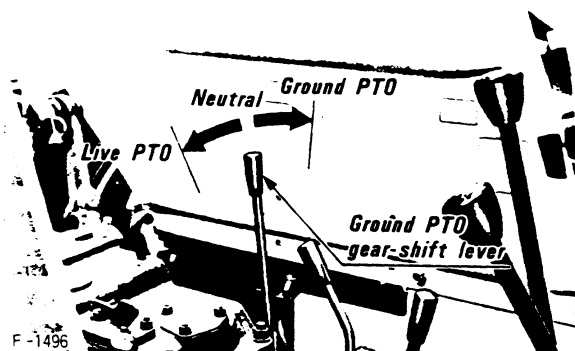

■ Three-point hitch

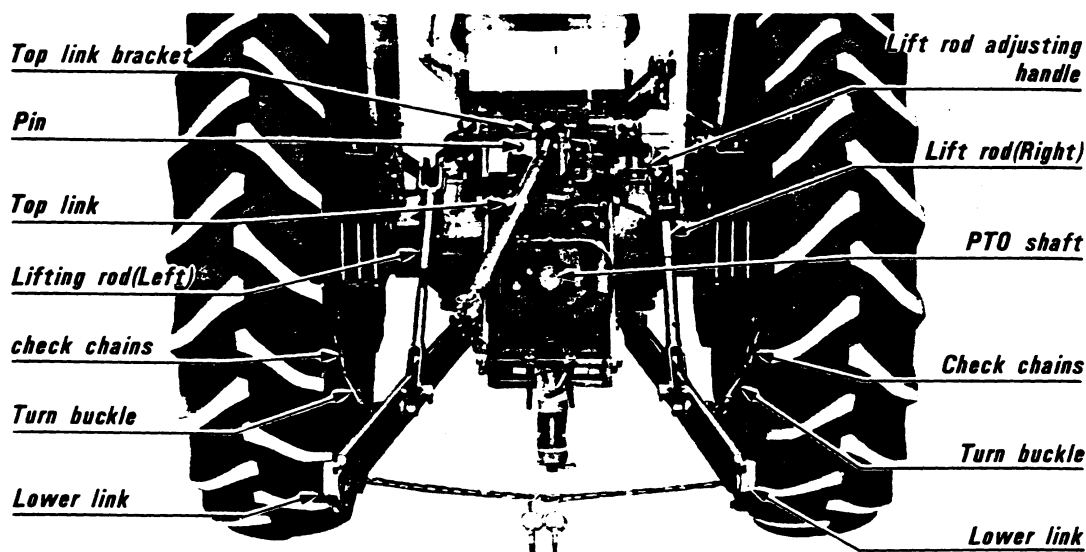

F-1498

(1) TOP LINK MOUNTING HOLES

Attach the top link to the tractor at one of the three holes referring to the "Hydraulic control unit use reference chart" on page 18. Most sensitive draft control is possible at the top hole which is usually employed for light jobs.

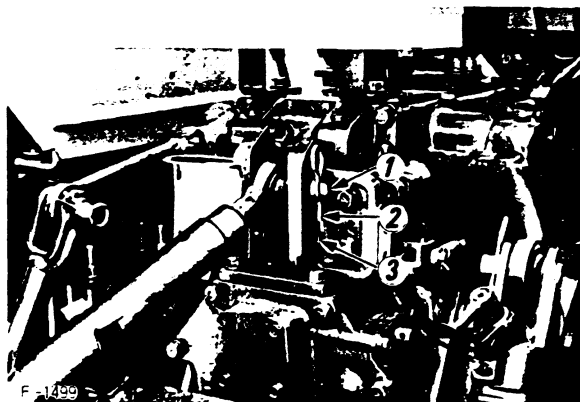

F-1499

OPERATION

■ Hydraulic unit

The hydraulic unit consists of the lifting system which comprises a hydraulic cylinder and control valve, and the engine drive hydraulic pump and pipe.

(1) LIFTING CAPACITY

Maximum lifting capacity is 3300 lbs. (1500kg) (at the end of the lower links).

(2) OPERATION

The hydraulic unit can perform the following three types of controls depending on the implement to be used.

● Position control

Position control is achieved by maneuvering the position control lever with the draft control lever put in the lowest position. This control is used for operations where the hydraulic system is floated.

● Draft control

Draft control is achieved by maneuvering the draft control lever.

● Mixed control

In draft control, when draft decreases, the implement automatically lowers to increase draft. However, the implement is sometimes lowered too much. To limit the degree the implement can be lowered, thus increasing working efficiency and achieving good results, position control can be added. This mixed control automatically controls the implement position hydraulically by draft control, and the draft decreases by position control.

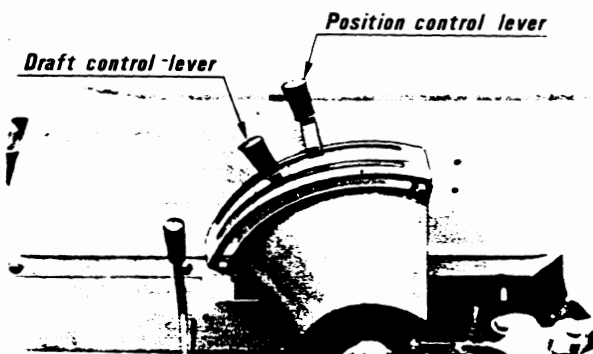
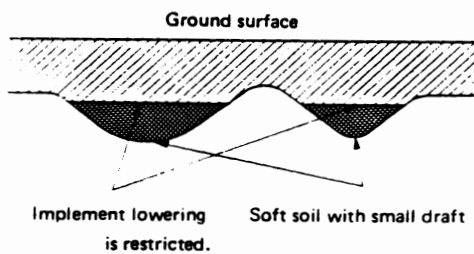

■ Hitch points

Implements to be mounted on the tractor must have hitch points as illustrated below for accurate hydraulic operation. Their weight should not exceed 1213 lbs. (550kg).

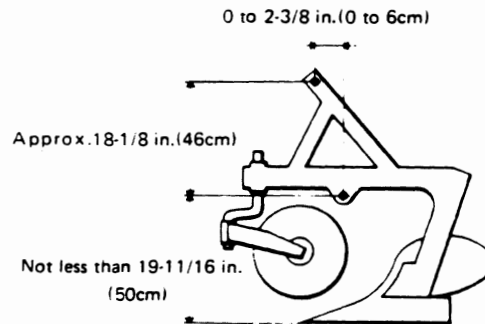

[NOTE]

- (1) The dimensions in the example illustrated above should be followed.
- (2) While the tractor is travelling with an implement, the implement must be at three hitch points and with the check chains properly tightened.

■ **Hydraulic control unit use reference chart**

In order to handle the hydraulic unit properly, the operator must be familiar with the following. Though this information may not be applicable to all types of implements and soil conditions, it is useful for most general situations.

Implement	Soil quality	Top link mounting holes	Draft control lever Position control lever	Gauge wheel	Check chains	Remark
Bottom plow: One-bottom (ordinary or rollover).....	Light soil	3 or 2	Position lever	No	Adjust the check chains so that the implement can move 5 to 6cm laterally.	
Two-bottom (ordinary or rollover).....	Medium soil	3 or 2	draft lever	No	Check chains should be tight enough to prevent excessive implement movement when implement is in raised position.	
Three-bottom	Heavy soil	2 or 1	Mixed control or draft control	No		
Disc plow: Two-bottom (ordinary or rollover).....	Light soil	3 or 2		No		
Three-bottom	Medium soil	2		No		
Harrower (spike, springtooth, disc type)	Heavy soil	1		No		
Sub-soiler	Light soil	1		No		
Ditcher	Medium soil	1		No		
Weeder, ridger	Heavy soil	2		Yes	Tighten	Put the position control lever in the lowest position during operation.
Earth mover, digger, scraper, manure fork, rear carrier		1	Position control	Yes/No	Tighten	With implements with gauge wheels, lower the position control lever all the way.
Mower (mid- and rear-mount type) Hay rake, tedder		1		No	Tighten	

OPERATION

■ Drawbar

The tractor is equipped with a swinging drawbar. The adjustment on the drawbar combined with the adjustment on most pull-type implements should give you sufficient control of draft to minimize wheel slippage and control front-end lift. The drawbar may be allowed to swing or may be held stationary by the placement of the pins in the drawbar carrier.

To make lengthwise adjustment in the drawbar the pivot pin located underneath the tractor differential housing must be removed. With the pin removed the drawbar may be repositioned and the pivot pin installed into the desired pivot hole.

A cross drawbar may be fitted to the three point hitch. When a cross drawbar is used, the position control lever the hydraulic control quadrant should be used.

[CAUTION]

DO NOT ATTACH ANY IMPLEMENT, PULL-CHAIN OR ROPE TO ANY POINT ON THE TRACTOR ABOVE THE CENTER LINE OF THE REAR AXLE.



■ Parking the tractor



When parking the tractor, lock the brake pedals together and set the parking brake. Leave the tractor in gear if you are parking on an incline. For additional safety, place a large block of wood or a stone underneath one rear wheel to prevent the tractor from rolling unexpectedly.

■ Towing the tractor

Do not tow the tractor at speeds faster than the tractor would travel under its own power. Towing the tractor at high speed may make the tractor difficult to handle and can result in serious tire damage.



When towing or pulling the tractor do not attach a tow line to any point above the center line of the rear axle. Attachment of a tow line above the center line of the rear axle may cause the tractor to tip over backwards.

9. WHEEL ADJUSTMENT

■ Front wheels

Tread is adjusted at 50-3/8 in. (M4500 · M5500)/53-7/8 in. (M7500) at shipment.

- (1) Lift the front of the tractor with a jack.
- (2) Remove the front axle mounting bolts and the tie-rod mounting bolts.
- (3) Move the front axles (right and left) to the desired position, and tighten them with bolts.
- (4) Adjust the toe-in.

■ Rear wheels (Pan type or dish type)

The rear wheels can be adjusted to different settings.



To adjust the rear wheels lift the rear of the tractor with a jack. Select the width desired and, if necessary, remove wheel center from rim. Remount the rim to relocate the tire center and attach wheel to the tractor. Check to see that the tire is turning in the proper direction as indicated by the arrow on the side of the tire. Rear wheel weights can be attached to the rim at any tread setting.

FRONT WHEEL ADJUSTMENT CHART

[DT-types]

M4500DT	55-7/8 in.	(1420mm)
M5500DT	55-7/8 in.	(1420mm)
M7500DT	57-7/8 in.	(1470mm)

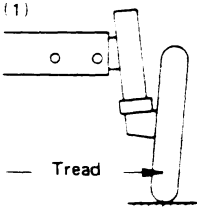
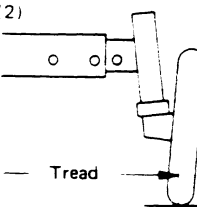
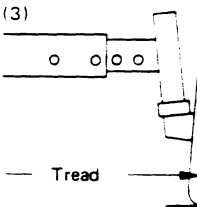
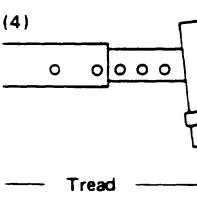
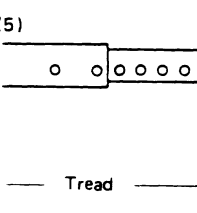
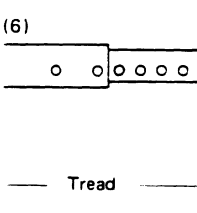
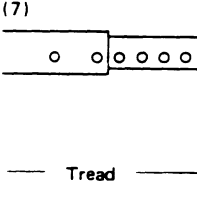
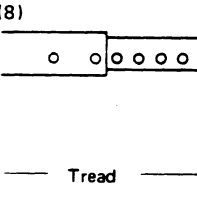
[Standard-types]

(1)		(2)		(3)	
M4500	50-3/8 in. (1280mm)	M4500	54-5/16 in. (1380mm)	M4500	58-1/4 in. (1480mm)
M5500	50-3/8 in. (1280mm)	M5500	50-3/8 in. (1280mm)	M5500	54-5/16 in. (1380mm)
M7500	53-7/8 in. (1370mm)	M7500	57-7/8 in. (1470mm)	M7500	61-13/16 in. (1570mm)
(4)		(5)		(6)	
M4500	62-3/16 in. (1580mm)	M4500	66-1/8 in. (1680mm)	M4500	70-1/16 in. (1780mm)
M5500	58-1/4 in. (1480mm)	M5500	62-3/16 in. (1580mm)	M5500	66-1/8 in. (1680mm)
M7500	65-3/4 in. (1670mm)	M7500	69-11/16 in. (1770mm)	M7500	73-5/8 in. (1870mm)
(7)		(8)		 <p>[CAUTION] THE WIDTH OF THE TREAD FOR THE FRONT LOADER SHOULD NOT BE GREATER THAN 59 INCHES (1500 mm)</p>	
M4500	74 in. (1880mm)	M4500	78 in. (1980mm)		
M5500	70-1/16 in. (1780mm)	M5500	74 in. (1880mm)		
M7500	77-1/2 in. (1970mm)				

REAR WHEEL ADJUSTMENT CHART

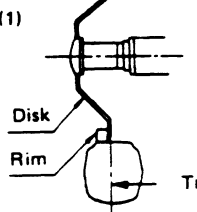
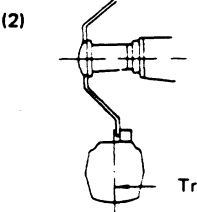
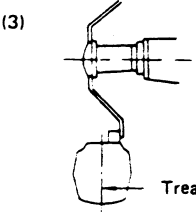
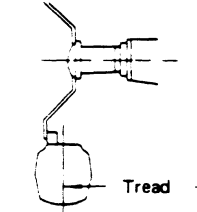
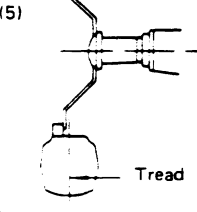
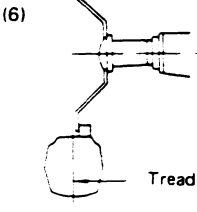
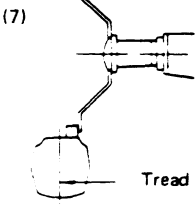
(1)		(2)		(3)		(4)	
M4500 (DT)	51-3/16 in. (1300mm)	M4500 (DT)	55-1/8 in. (1400mm)	M4500 (DT)	59-1/16 in. (1500mm)	M4500 (DT)	63 in. (1600mm)
M5500 (DT)	51-3/16 in. (1300mm)	M5500 (DT)	55-1/8 in. (1400mm)	M5500 (DT)	59-1/16 in. (1500mm)	M5500 (DT)	63 in. (1600mm)
M7500 (DT)	51-3/16 in. (1300mm)	M7500 (DT)	55-1/8 in. (1400mm)	M7500 (DT)	59-1/16 in. (1500mm)	M7500 (DT)	63 in. (1600mm)
(5)		(6)		(7)			
M4500 (DT)	66-15/16 in. (1700mm)	M4500 (DT)	70-7/8 in. (1800mm)	M4500 (DT)	74-13/16 in. (1900mm)		
M5500 (DT)	66-15/16 in. (1700mm)	M5500 (DT)	70-7/8 in. (1800mm)	M5500 (DT)	74-13/16 in. (1900mm)		
M7500 (DT)	66-15/16 in. (1700mm)	M7500 (DT)	70-7/8 in. (1800mm)	M7500 (DT)	74-13/16 in. (1900mm)		

FUEL AND LUBRICANT SPECIFICATIONS

1. FUELS	23
■ Fuel specifications	23
■ Fuel storage	23
■ Filling the tractor fuel tank	23
2. LUBRICANTS	23

10. FENDER ADJUSTMENT

The fenders may be adjusted in and out with the wheels. To adjust the fenders, loosen the fender mounting nuts which are located on the bottom of the axle near the check chain brackets. Relocate the fender making sure there is sufficient clearance between the fender and tire. When the fender is adjusted correctly the fender mounting bolts should be in one of the slots cast into the axle housing. With the fender in the desired position tighten the mounting nuts.



[CAUTION]

The fenders are designed to prevent loose material from flying up and striking the driver and to shield the driver from the turning tire. Keep the fenders properly adjusted and keep the fender mounting bolts tight. Under no circumstances should anyone be allowed to ride on the tractor while sitting on the fenders.

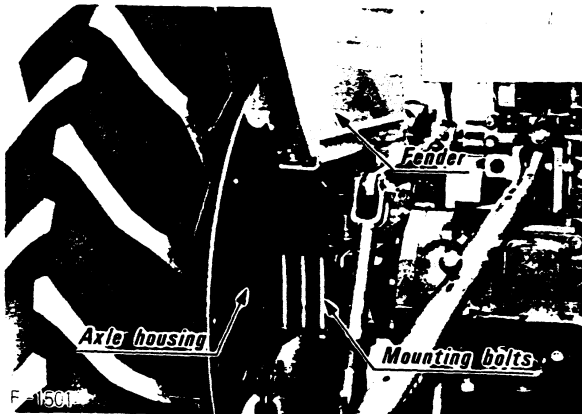

11. WEIGHTING THE TRACTOR

■ Front bumper weights

It may be necessary to mount front bumper weights on the tractor if the tractor is to be operated with heavy three point mounted or drawn implements. A front weight frame and KUBOTA suitcase weights are available from your KUBOTA Dealer. Your dealer can help you decide how much weight is required for your particular application.

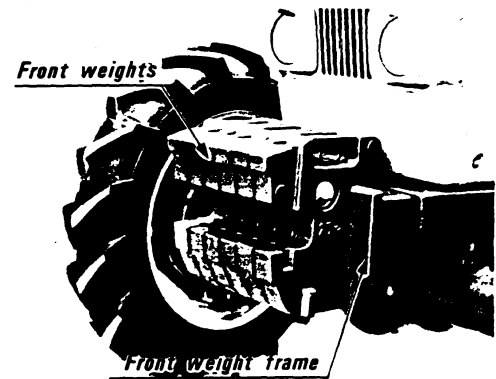

F-1502

■ Rear wheel weights

Rear wheel weights may be mounted on the rear wheels. Consult your Kubota dealer for the correct weight necessary for your particular application.



F-1503

1. FUELS

Always use quality fuel. Be sure the fuel is clean, completely distilled, well-refined and free of water. This is extremely important as the engine fuel injection system is designed with very close tolerances. Dirt and moisture can clog or damage the fuel system.

In order to assure that the fuel is acceptable quality, it is recommended that you purchase your fuel from a reputable dealer selling a known brand of fuel. A few cents saved on less expensive fuel could quickly be lost if repairs to the fuel system are required as a result of using inferior fuel.

■ Fuel specifications

For most applications, diesel fuel number 2 (no. 2D) should be used. Diesel fuel no. 2 is a heavier fuel and produces more work (or energy) per gallon than diesel no. 1. Recommended fuel depends on ambient air temperature and altitude. When operating in temperatures below 20°F (-6.6°C) or at altitudes above 5000 feet (1,524m) use diesel fuel no. 1. For all other applications use diesel fuel no. 2. Your KUBOTA tractor will operate best on fuels with the following specifications:

- (1) Less than 1.0% sulphur content in the fuel, preferably less than 0.5%.
- (2) Water content should not exceed 0.10%.
- (3) In cold weather operating conditions where number 1 diesel is used the fuel should have a pour point at least 10 degrees below the lowest ambient air temperature.

■ Fuel storage



[CAUTION]

If spilled, diesel fuel will not evaporate. Clean up all spills or they will collect dirt and dust. Diesel fuel is flammable. Keep open flames away from fuel and fuel storage facilities.

It is often desirable to store large quantities of fuel at your farm or place of business. It is important to keep this fuel free of dirt and excess moisture during storage. Fuel should be stored in black iron tanks or containers. Do not store diesel fuel in galvanized tanks. The zinc coating on the tank will react with the fuel forming compounds which may damage the tractor fuel system.

If you store large quantities of fuel, the storage tank should be positioned so that the rear of the tank lies well below the point from which the fuel is drawn. A tilted tank allows sediment and water to settle away from the pour point. In addition it is recommended that our storage tank be equipped with a drain plug located at the lowest point on the tank so that water and sediment may be drained off periodically.

After filling your fuel storage tank allow the fuel to settle for at least twelve hours. This will allow the suspended sediment in the fuel to collect at the low point in the tank. Keeping the fuel tank as full as possible at all times will prevent the build-up of excess moisture in the stored fuel.

Whether you use a pump type or gravity feed type fuel transfer system, an in line filter should be installed in the system as added protection to prevent dirt and water from entering the tractor fuel system.

If you store your fuel in a 55 gallon drum, follow the instructions above. Never tip the barrel to get to the residue fuel left in the bottom.

■ Filling the tractor fuel tank

The fuel tank on the KUBOTA tractor is located between the instrument panel cowling and the engine firewall. The fuel tank design incorporates a built-in removable plastic fuel screen. This screen acts to filter out dirt and sediment and should be kept in place at all times when filling the fuel tank. When the fuel filter screen becomes dirty, it may be removed from the tank and washed with clean fuel. Be sure this screen is clean before filling the fuel tank.

Fill the fuel tank at the end of the day. A full fuel tank will minimize moisture build-up from condensation and help to protect the fuel system from corrosion and dust build-up.

Fuel tank Capacity: 14.3 gallons (54 ℓ)

2. LUBRICANTS

Adherence to suggested lubrication frequencies and the use of recommended lubrication oils and greases will assure, more than any other single factor, long and trouble-free service from your tractor. Read this section carefully to familiarize yourself with the lubrication requirements of your tractor.

(1) ENGINE OIL

Oil used in the engine should have an American Petroleum Institute (API)/SAE Classification of service CD. The chart below shows the correct weight oil to be used at various temperature conditions:

Below 32°F	SAE10W or 10W-30
Between 32° and 77°F	SAE20 or 10W-30
Above 77°F	SAE30 or 10W-30

(2) TRANSMISSION OIL

The oil used to lubricate the transmission is also used as hydraulic fluid. To insure proper operation of the hydraulic system and complete lubrication of the transmission it is important that only recommended oils be used in this system. The following are recommended oils, by brand name, that may be used in the transmission hydraulic system.

Allis Chalmers	821 Power Fluid
Atlantic Richfield (Arco)	Arco Tractor Fluid
Case	TCH
Chevron	Tractor Hydraulic
Exxon	Torque Fluid 56
Ford	M2C41 Tractor Hydraulic Oil
International	Hy Trans
John Deere	303, J14C
Massey	M1127 Fluid
Penzoil	Hydra-Trans and Wet Brake
Phillips	H. T. Fluid
Shell	Donax T-4
Texaco	T. D. H. Oil
Union	Hydraulic/Tractor Fluid
Valvoline	Uni-Trac

(3) POWER STEERING

The power steering system uses SAE 80/90 weight oil.

(4) FRONT WHEEL BEARINGS [Standard-types]

Lubricate the front wheel bearings with SAE lithium based grease.

(5) STEERING GEAR BOX

Lubricate the steering gear box with SAE 80/90W gear oil.

(6) CHASSIS GREASE FITTINGS

Lubricate the chassis grease fittings with lithium based grease. For location of chassis lubrication points see service section of this manual.

(7) FRONT WHEEL DRIVE UNIT [DT-types]

Lubricate front differential and bevel gears with SAE 80/90 weight gear oil.

(8) LUBRICANT CAPACITY CHART

Component	Capacity		
	M4500(DT)	M5500(DT)	M7500(DT)
Engine crankcase	13.4 qts. (12.7 ℓ)	10.4 qts. (9.8 ℓ)	12.5 qts. (11.8 ℓ)
Transmission hydraulic system	47.6 qts. (45 ℓ)		
Power steering system	2.1 qts. (2 ℓ)		
Steering gearbox	0.5 qt. (0.5 ℓ)		
Front wheel drive unit [DT-types]			
Differential	3.7 qts. (3.5 ℓ)		
Bevel gears	0.8 qt. (0.8 ℓ)		
Front axles	3.7 qts. (3.5 ℓ)		

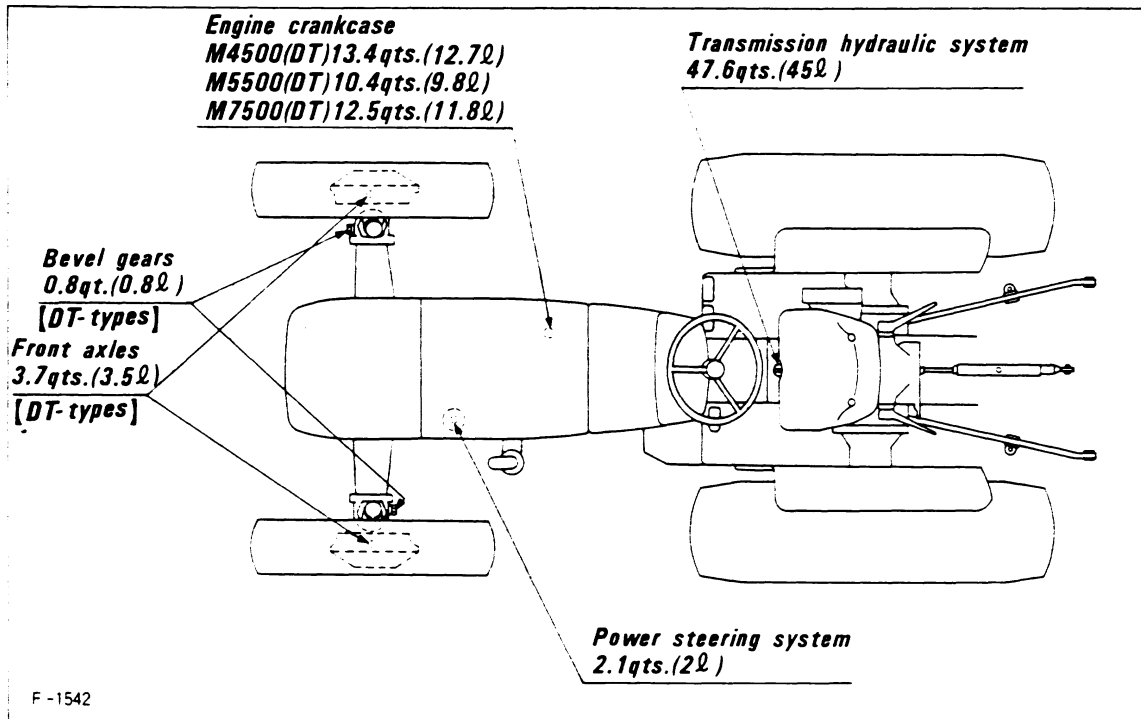

FUEL AND LUBRICANT SPECIFICATIONS

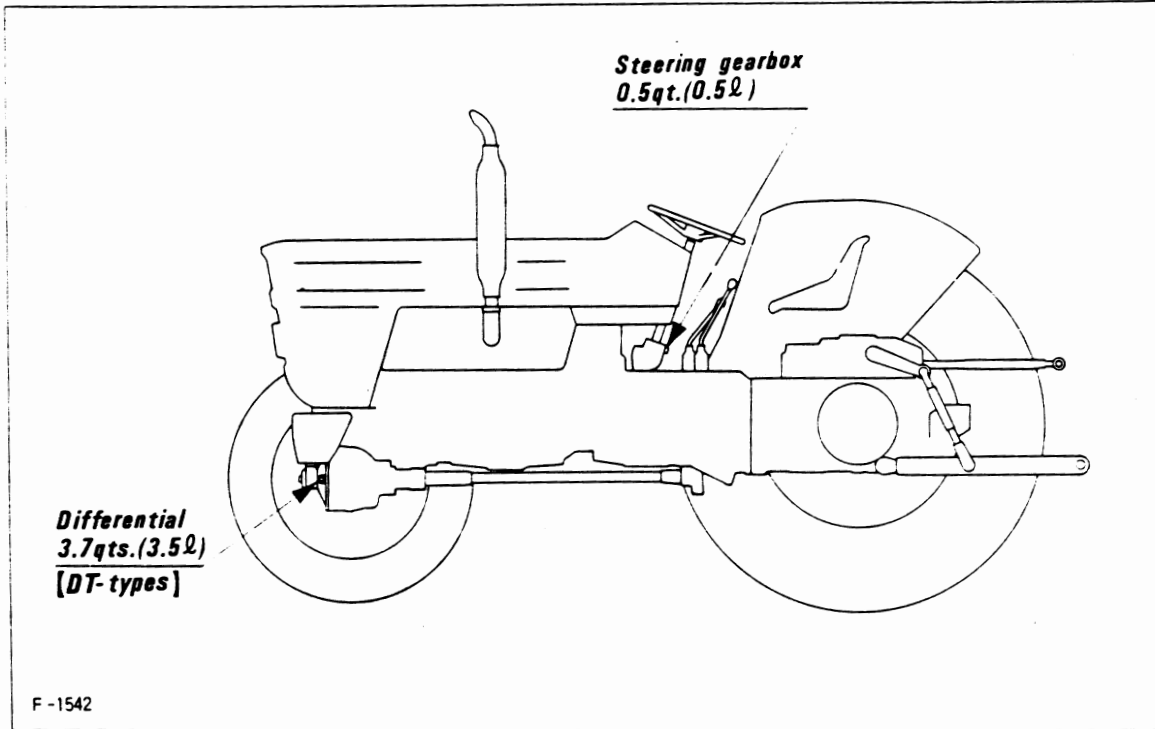

(9) STORING LUBRICANTS

Store lubricants in a clean, dry area. When handling lubricants, use clean containers that are free from moisture and dust. Use of contaminated lubricants in the tractor will shorten machine life.

MAINTENANCE

1. BREAK-IN PROCEDURE	27
2. LUBRICATION INTERVALS DURING BREAK-IN PERIOD .	27
■ Engine oil	27
■ Transmission/hydraulic system oil.	27
3. OTHER CHECKS DURING BREAK-IN PERIOD	27
4. SERVICE AND LUBRICATION INTERVALS	27
5. PERIODIC SERVICE PROCEDURES	27
■ Cleaning the air filter	27
■ Washing the air filter element	28
■ Inspecting the air filter	28
■ Changing engine oil	29
■ Checking the engine oil level	29
■ Changing the engine oil filter	29
6. FUEL SYSTEM MAINTENANCE	30
■ Fuel filter	30
■ Fuel system bleeding procedure	31
■ Fuel injection pump	32
7. TRANSMISSION/HYDRAULIC SYSTEM MAINTENANCE	32
■ Changing transmission/hydraulic oil	32
■ Cleaning the transmission/hydraulic system oil filter	32
8. COOLING SYSTEM	33
■ Flushing the cooling system	33
■ Cleaning the radiator net	33
■ Antifreeze	34
■ Repairing radiator leaks	34
■ Radiator hoses (Water pipes)	34
9. ELECTRICAL SYSTEM	34
■ Battery	34
■ Alternator and voltage regulator	36
■ Alternator and voltage regulator servicing procedures	36
■ Starter	36
■ Fuses	36
■ Protected circuits	37
10. FAN BELT ADJUSTMENT	37
11. PERIODIC SERVICE SCHEDULE	38
12. BATTERY TROUBLE SHOOTING	39
13. ENGINE TROUBLE SHOOTING	40

Routine maintenance is based on operating hours as indicated by the engine hour meter located on the face of the tachometer. The hour meter shows the accumulated operating time for the engine. The hour meter is designed to register one hour of operating time for each hour of engine operation at 2200 RPM. Engine operation at less than 2200 rpm will result in an hour meter reading that is proportional to engine speed.

1. BREAK-IN PROCEDURE

Please refer to the operations section of this manual for operating instructions during break-in period.

Maintenance procedures during the break-in period consist of an engine oil and filter change at 35 hours and a transmission/hydraulic oil and filter change (and if your tractor is equipped with four wheel drive an oil change of the front differential oil) at 50 hours.

Since the tractor is new and you are unfamiliar with the operation of the machine it is suggested that you make careful visual inspections of the entire machine prior to operating the tractor during the break-in period.

2. LUBRICATION INTERVALS DURING BREAK-IN PERIOD

■ Engine oil

Change the engine oil and engine oil filter at the end of 35 hours of operation. If it becomes necessary to add engine oil during the break-in period add correct wt. oil.

■ Transmission/hydraulic system oil

Change the transmission/hydraulic oil and oil filter at the end of the first fifty (50) hours of operation. If it becomes necessary to add large quantities of oil to the transmission/hydraulic system prior to the first oil change, drain all oil in the system and replace with new oil of specified weight and grade.

3. OTHER CHECKS DURING BREAK-IN PERIOD

Check the following during the break-in period (first sixty hours of operation).

- (1) Tighten all wheel lug bolts after the first eight hours of operation. If the tractor is equipped with a front loader, check the front lug bolts for tightness every forty (40) hours of operation throughout the operating life of the tractor.
- (2) Tighten the mounting bolts on the front and rear wheel weights, the front weight frame and front weights after the first eight hours of operation.
- (3) Check the tractor daily for water or oil leaks.
- (4) Make sure tractor is greased. Be sure you are familiar with all chassis grease points. See the lubrication and service time chart for location of lubrication points.
- (5) Check all oil levels twice daily. Add oil if necessary.
- (6) Observe the instruments at regular intervals during operation.

4. SERVICE AND LUBRICATION INTERVALS

Recommended service and lubrication intervals are based on service requirements for a tractor being used under average operating conditions. If your tractor is being operated under severe operating conditions (such as extreme dusty conditions, frequent starting and stopping of the engine, operation in extreme temperature conditions, etc.) it may be necessary to perform various service procedures more frequently than is recommended. Under no circumstance should the suggested service intervals be extended beyond those recommended in this manual.

Careful adherence to the suggested service procedures and service schedules will insure trouble-free and safe machine operation and promote machine longevity.

5. PERIODIC SERVICE PROCEDURES

■ Cleaning the air filter

The KUBOTA tractor is equipped with a dry element air filter. The air filter is located in front of the radiator behind the sheet metal grille at the front of the tractor.

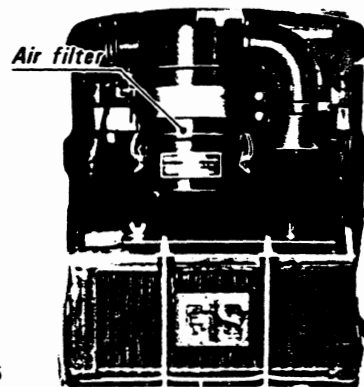

The air filter element should be cleaned on a regular basis. The frequency of cleaning should correspond with the severity of the conditions under which the tractor is being operated; that is, the filter must be cleaned frequently if the tractor is being operated in extremely dusty conditions.

The air filter is equipped with a restriction indicator which, through the use of a colored indicator, indicates when the filter is clogged and in need of cleaning. Whenever the bright orange indicator comes into full view, the air filter element must be cleaned immediately. Other indicators of a clogged air filter are the loss of engine power, excessive exhaust smoke and increased fuel consumption. If the tractor displays any of these operating characteristics, stop the engine immediately and check the air filter.

AIR FILTER RESTRICTION INDICATOR

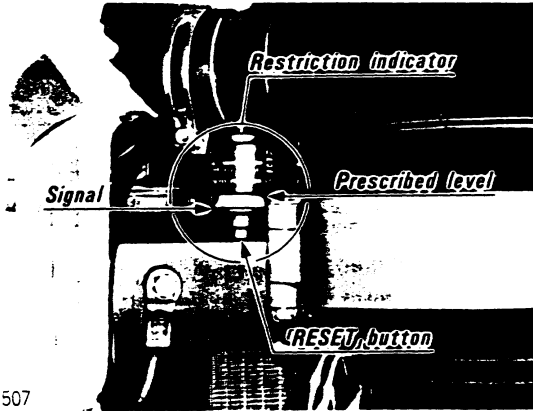

F-1507

To service and clean the air filter element, remove the front grille to gain access to the filter element cannister. Loosen the retaining ring on the cannister and remove the dust cup on the bottom of the cannister. The air filter is held in position by a wing nut. Remove the wing nut and pull the filter element out.



F-1504

To clean the element, first shake off loose dirt by tapping the element casing against the palm of your hand. Compressed air may be used to clean the element but care must be taken not to damage the paper element with excessive air pressure. When using compressed air, always blow from the inside of the filter out.

■ Washing the air filter element

In the event compressed air and light tapping of the air filter element do not clean the element sufficiently, the element can be washed. Before washing the element, remove as much dirt as possible with compressed air. To wash the element, soak the filter in warm water and cleaning solution. Rinse the element from the inside with clean water to remove all dirt. Allow the filter to dry completely before reusing.



[CAUTION]

Do not operate the tractor with the air filter removed or with a damp air filter element.

■ Inspecting the air filter

With a flashlight or unshaded lightbulb, take the cleaned filter element into a dark room or closet. Place the light inside the filter element and rotate the element looking for shafts of light that indicate that there are holes in the element paper. If there are any holes in the element paper, the element must be replaced. Before reinstalling the filter element check the rubber sealing gasket on the end of the element. If this gasket is damaged the filter element must be replaced.

[CAUTION]

The air filter element is designed to protect the tractor engine from damaging dust. Failure to clean the filter may result in engine damage. Keep your engine running well. Keep the air filter clean!

MAINTENANCE

■ Changing engine oil.

The engine oil must be changed every 150 hours of operation. Before changing the engine oil run the engine until it is warm. Turn the engine off.

Place an oil catch pan under the crankcase. Remove BOTH crankcase drain plugs and allow all the engine oil to drain from the engine. Replace BOTH drain plugs and refill the crankcase with new oil of appropriate weight for your operating conditions (see the chart below for oils to be used under various operating conditions). Do not start the engine until the oil filter has been replaced.

CRANKCASE DRAIN PLUG

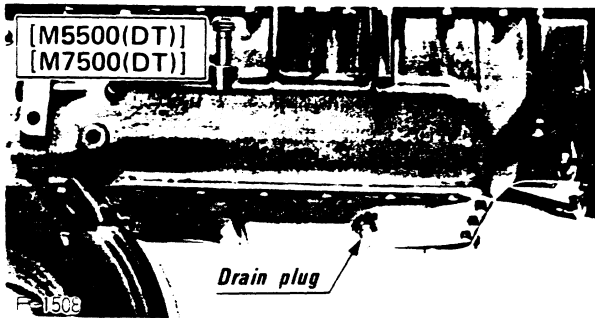

CRANKCASE OIL FILL PORT

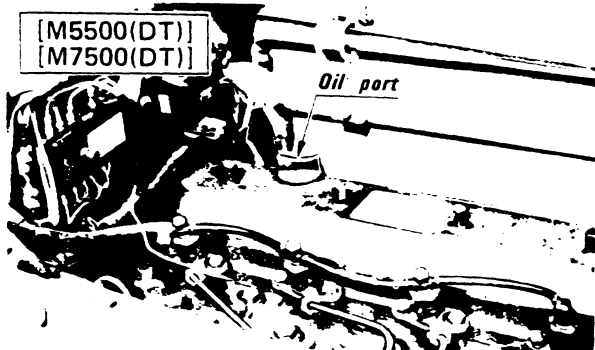
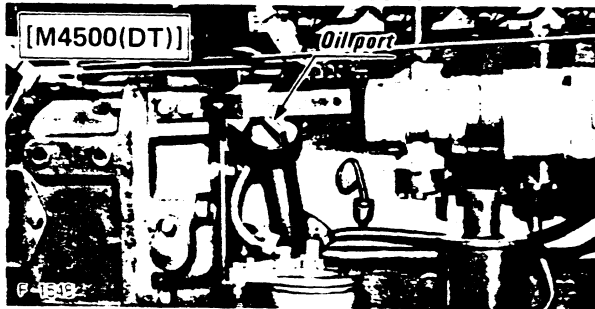

ENGINE OIL VISCOSITY CHART

Oil used in the engine should have an American Petroleum Institute (API)/SAE Classification of service CD.	
Average temperature	Recommended oil
Below 32°F	SAE10W or 10W-30
Between 32° and 77°F	SAE20W or 10W-30
Above 77°F	SAE30W or 10W-30

■ Checking the engine oil level

To check the engine oil level, first remove the right hand engine safety screen. Remove the dipstick and check the oil level. If the oil level is below the bottom mark on the dipstick, add oil to the crankcase through the oil fill port until the crankcase is full. If it is necessary to add oil, be sure to add only oil of the same brand and weight as that in the crankcase. Never mix oils of different weights or brands.

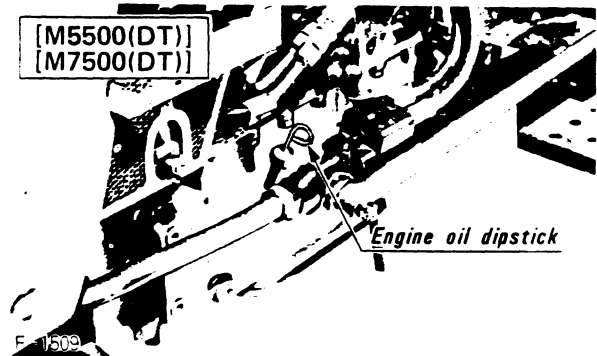
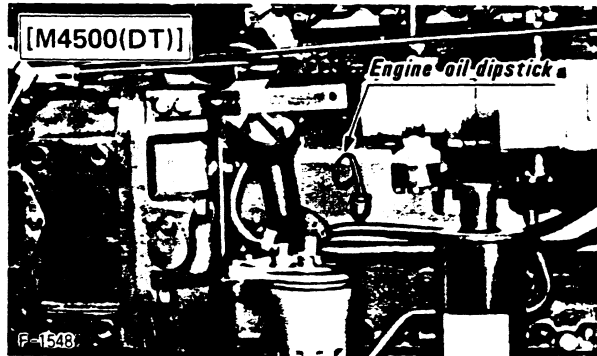

■ Changing the engine oil filter

[M4500(DT)]

- (1) Remove the oil filter (2) from the engine to replace elements. Disassemble and reassemble the filter correctly referring to the photo below.
- (2) If the oil filter is badly stained, remove it carefully so as not to scratch the relief valve and the pressure regulator valve. Clean it well and replace.

- (3) The engine oil level will decrease by the amount of oil which flows into the oil filter (2) after its reassembly and reattachment to the engine. It is thus necessary to fill the filter with engine oil before reattaching it to the engine. It is also necessary after reattaching it to run the engine to check for any trouble with engine parts and hydraulic pressure, and to see if the engine oil reaches the prescribed level, after the engine stops, and add oil if necessary.

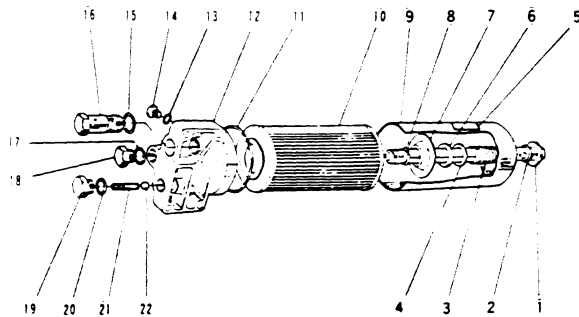

Oil Filter (2)

- | | |
|---------------------------------|---------------------------------------|
| (1) Center pipe | (12) Oil strainer cover |
| (2) Center pipe packing | (13) Packing |
| (3) Element spring | (14) Plug (small) |
| (4) Washer (small) | (15) Pressure regulator valve packing |
| (5) Name plate | (16) Relief valve |
| (6) Felt packing | (17) Packing |
| (7) Washer (large) | (18) Plug (large) |
| (8) Cir-clip | (19) Escape valve plug |
| (9) Body | (20) Packing |
| (10) Oil strainer element | (21) Escape valve spring |
| (11) Oil strainer cover packing | (22) Escape valve |

[M5500(DT)]
[M7500(DT)]

The oil filter used is a cartridge type. If it becomes clogged, the by-pass valve is actuated (1.2 to 1.6kg/cm^2) to calculate oil. However, oil is not filtered, and trouble may occur. Be sure to replace cartridges every two oil changes or within 400 hours.

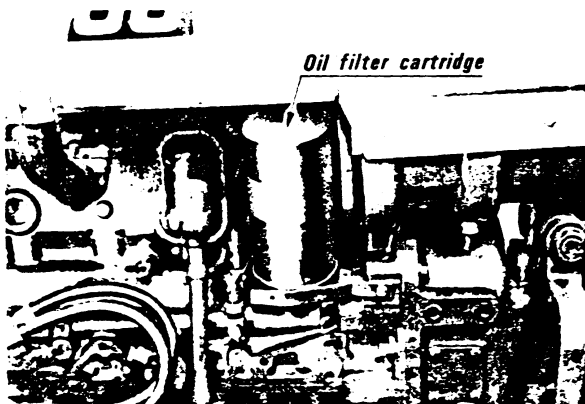

6. FUEL SYSTEM MAINTENANCE

■ Fuel filter

(1) REPLACING THE FUEL FILTER

The fuel filter should be replaced every 200 hours of operation. Use of contaminated fuel may require more frequent fuel filter replacement. To replace the fuel filter, close the fuel petcock at the fuel tank. Using the filter wrench provided with the tractor, unscrew and remove the filter. Install a new filter and tighten the filter by hand only. Open the fuel tank petcock and bleed the fuel system to remove trapped air. Run the engine and check for fuel leaks.

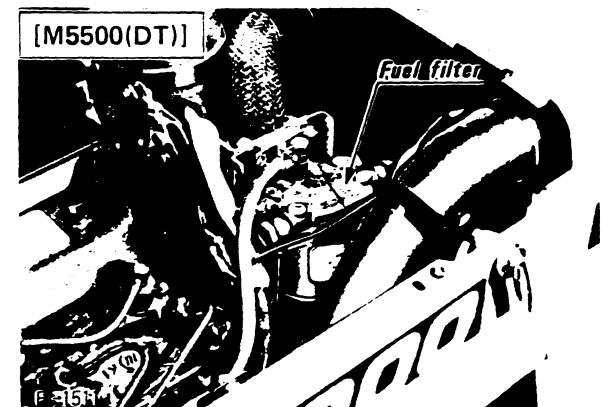
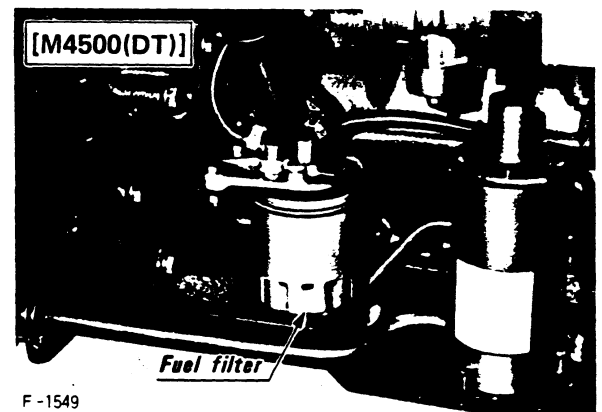

MAINTENANCE

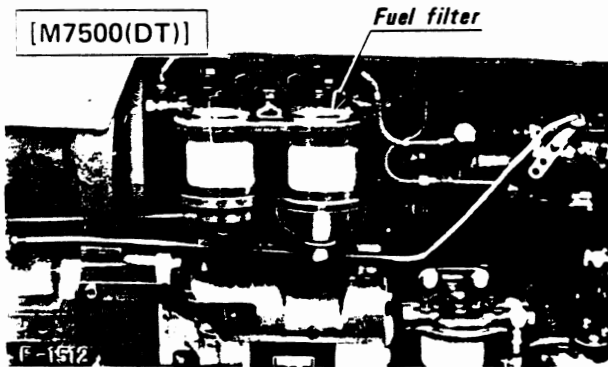

Fuel system bleeding procedure

Air must be removed:

- (1) when the fuel filter and piping are removed,
- (2) when fuel is used up, and
- (3) after the tractor has not been used for long periods of time.



Stop the engine before air bleeding.

[PROCEDURE]

[M4500(DT)]

- (1) Fill the fuel tank with fuel, and open the fuel cock.
- (2) Loosen the air vent plug at the top of the filter with two turns.

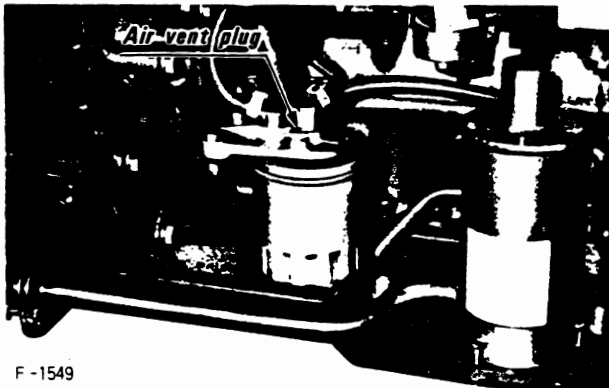

- (3) When bubbles disappear from fuel coming out of the plug, twist it back.
- (4) Open the air vent cock on the fuel injection pump.



- (5) Pull the engine stop knob to stop the engine, and start the cell motor for about 10 seconds.

[CAUTION]

Always pull out the engine stop knob before starting the cell motor.

- (6) Close the air vent cock.

[M5500(DT)] [M7500(DT)]

- (1) Fill the fuel tank with fuel, and open the fuel cock.
- (2) Check to see if fuel is being supplied by moving the feed pump lever vertically. Judge from the fuel flow and the response of the lever. If no fuel is being fed, turn on the starter switch for a second, and turn the crank shaft a little.

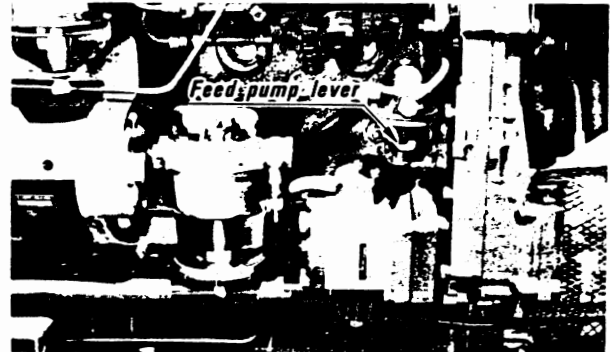

- (3) Loosen the plug 1 2 3 4 by about two turns and the four box nuts 5 on the nozzle side of the fuel injection pipes, and pressure-feed fuel using the pump lever.



[M5500(DT)]

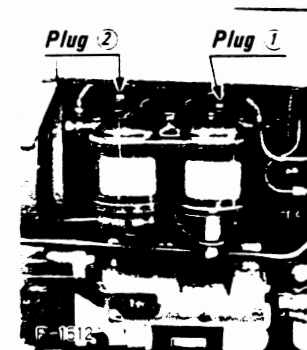

[M7500(DT)]

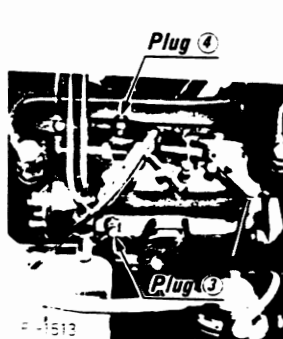

F-1512

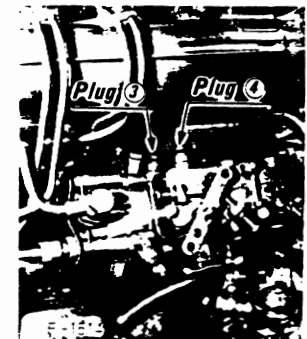

F-1512

- (4) First, when bubbles disappear from fuel coming out of the plug 1, twist it back.
Next, bubbles disappear from fuel coming out of the plugs 2 3 4, twist it back.
- (5) Put the accelerator lever at the maximum speed position with the engine stop knob pushed in, turn on the starter switch to start the engine. Hold until bubbles come up with force around the box nuts, and then stop the engine and tighten the nuts.
- (6) Then the engine is prepared for starting, and put the accelerator lever at minimum speed position with engine stop knob pushed in, turn on the starter switch to start the engine. Hold until bubbles come up around the plug 4, and then stop the engine and twist it back.
- (7) Start the engine in the ordinary manner. At this point, do not return the accelerator lever to "Idling", but keep revving up the engine to exhaust a small portion of air left in the fuel system.

If air still remains and the engine stops even after the above steps, repeat bleeding at plug 2 → plug 3 → box nuts 5 → plug 4.

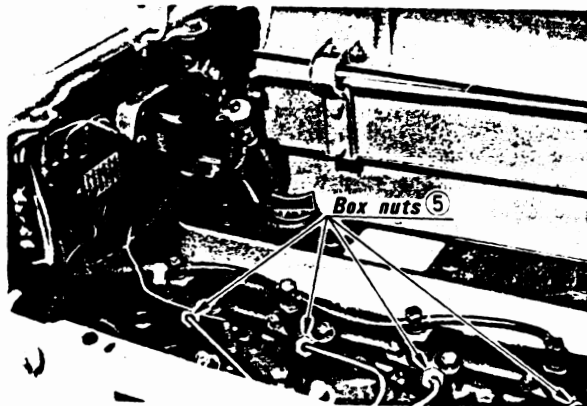

[CAUTION]

Always pull the engine shut-off knob before attempting to turn the engine over while bleeding the tractor fuel system.

■ **Fuel injection pump**

For service of the tractor fuel injection pump, see your Kubota Dealer.

7. TRANSMISSION/HYDRAULIC SYSTEM MAINTENANCE

■ **Changing transmission/hydraulic oil**

The transmission/hydraulic system oil must be changed every 600 hours. To drain the transmission/hydraulic oil, place an oil catch pan underneath the transmission. Remove BOTH oil drain plugs from the bottom of the transmission case. Allow all the oil to drain out. Replace the drain plugs. Refill the system through the transmission oil fill port. Fill to the top mark on the transmission dipstick.

TRANSMISSION DRAIN PLUGS

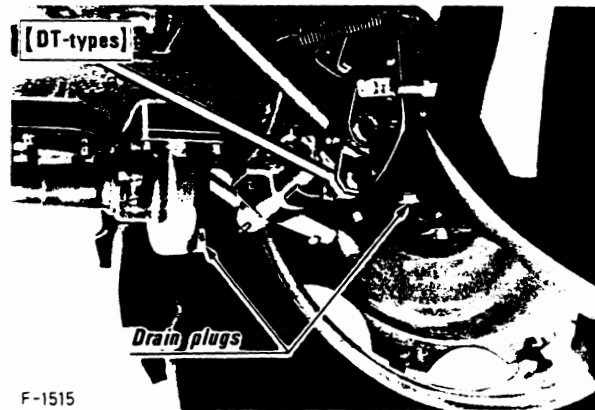
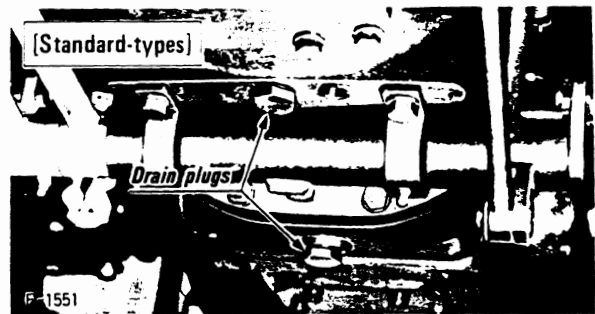

TRANSMISSION OIL FILL PORT AND DIPSTICK



[CAUTION]

Use only those oils listed in the lubrication section of this manual in the transmission/hydraulic system. Use of other oils may damage the transmission or hydraulic system.

■ **Cleaning the transmission/hydraulic system oil filter**

The transmission/hydraulic system oil filter must be cleaned every 200 hours. This filter is located on the right side of the engine just to the rear of and slightly above the engine oil filter.

Place an oil catch pan under the filter. Remove the three filter plate retaining nuts and the filter retaining plate.

MAINTENANCE

Remove the filter element and clean thoroughly with kerosene. Clean the magnetic filter and wipe out the inside of the filter case with a clean cloth. Allow the filter to dry thoroughly before it is replaced. If the filter is torn or otherwise damaged, it must be replaced. With the filter reinstalled and all three filter retaining plate nuts secured, run the engine and check for oil leaks. Check the transmission/hydraulic system oil level after the engine has been run. Fill as necessary.

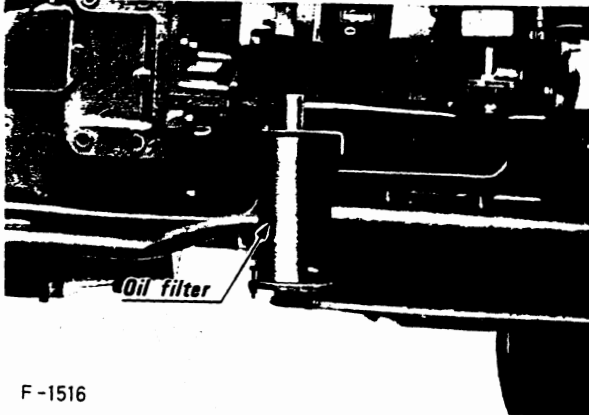

F-1516



[CAUTION]

The hydraulic system operates by pumping oil at extreme pressure. If a leak develops in a hydraulic line or fitting it may be almost invisible. If you suspect that there is a hydraulic leak in a line or fitting, do not place your hand or arm near the suspected leak. Use a piece of cardboard or wood held near the suspected leak to show the exact location of the leak. Hydraulic fluid is pumped at sufficient pressure to penetrate the skin and enter the blood stream causing serious personal injury. If you suspect you have been injured by escaping hydraulic fluid see a doctor at once.

8. COOLING SYSTEM

To insure proper operation of the engine cooling system, the cooling system must be flushed annually or every 800 hours, whichever comes first.

■ Flushing the cooling system

To flush the cooling system, run the engine until it reaches normal operating temperature. Stop the engine, loosen the radiator cap and drain all the coolant from the system by opening the petcocks on the radiator and engine block. The radiator petcock is located on the bottom front of the radiator. The engine petcock is located on the right side of the engine just below the fuel injection pump. With the system fully drained, close the petcocks and fill the radiator with a solution of commercial cooling system cleaner and water. Follow the instruction provided with the cleaner.

Drain the cooling system and flush with clear water. Refill the system with either anti-freeze or fur inhibitor depending on the prevailing weather conditions and seasons of use. Always drain and flush the radiator whenever changing from anti-freeze to fur inhibitor.

[M4500(DT)]

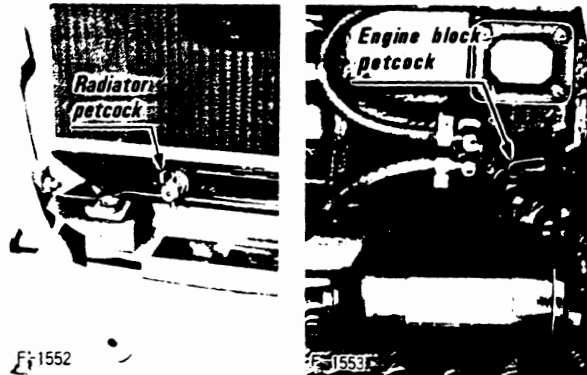

F-1553

F-1553

[M5500(DT)-M7500(DT)]

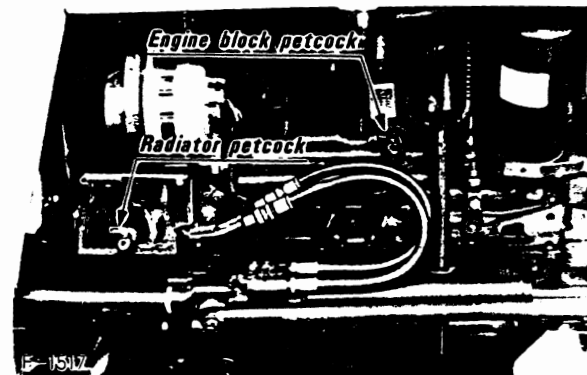

F-1517

■ Cleaning the radiator net

The radiator is equipped with a net designed to prevent small particles of debris from entering the radiator coils. This screen must be cleaned whenever it becomes clogged with material. Clean this screen with water by directing the water through the rear of the radiator. If the screen clogs, engine overheating may result.

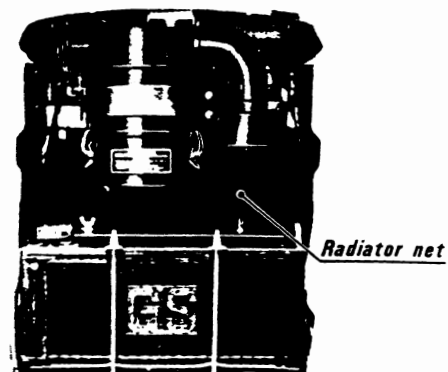

F-1506

■ **Antifreeze**

Use only permanent type antifreeze of known quality. For solution mixture follow directions provided with the antifreeze. If you experience coolant loss due to evaporation, refill the system with water. If coolant loss is due to leaks, refill with antifreeze.

■ **Repairing radiator leaks**

To repair small leaks use Kubota radiator cement #40. To repair large leaks, see your Kubota dealer.

■ **Radiator hoses (Water pipes)**

Check to see that the radiator hoses are tightly connected every 150 hours of operation or every 6 months, whichever comes first.

- (1) If a hose band comes loose, apply oil to the band screw and tighten it securely.
- (2) The radiator hoses are made of rubber and can wear out whether the tractor is used or not. Replace them with new ones every two years. It is necessary to change hose bands at the same time.

Name	Code No.	
	M4500(DT)	M5500(DT) M7500(DT)
Water pipe 1	15612-72851	15701-72851
Band 1	15108-72873	15701-72872
Water pipe	15612-72941	15451-72941
Band 2	15108-72873	15701-72962

- (3) Should a radiator hose or a band become damaged or a hose dislocated before the two years are up, replace or repair as soon as possible, it would be extremely dangerous if the radiator hose came off during operation and hot water gushed out.

9. ELECTRICAL SYSTEM

■ **Battery**

The tractor is equipped with a single 12 volt battery. If it becomes necessary to change the battery, use a battery of equal size and power.

BATTERY SPECIFICATIONS

TYPE	Volts (V)	Number of plate per cell	Capacity		Volume of Electrolyte (ℓ)	Normal Charging Rate (A)
			at 20HR (Ah)			
M4500(DT) G160-10	12	19	150	110	6.8	9
M5500(DT) M7500(DT) NX300-15	12	35	300	170	11.5	17

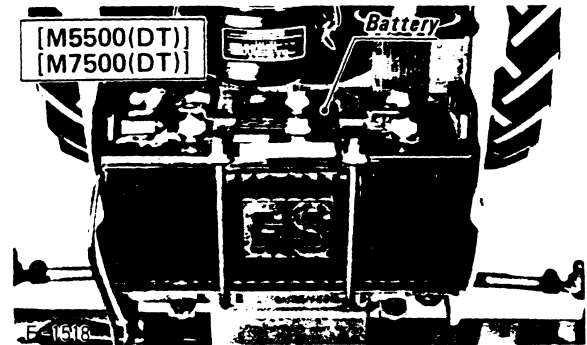
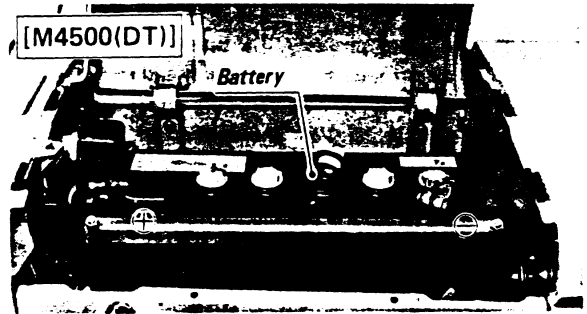

(1) **“Jump Starting”**

If it becomes necessary to connect a booster battery to the tractor battery to assist in starting the tractor in cold weather, or if the main battery is low, use the following procedure: connect the positive terminal on the booster battery to a ground point on the tractor. When grounding a booster battery do not ground the battery to thin metal or painted surfaces. Start the tractor following normal starting procedure.

(2) **CLEANING THE BATTERY**

Keep the battery case clean. Wipe the battery case off with a damp cloth whenever necessary. To clean the battery terminals, use a solution of baking soda and water (¼ pound of baking soda to one quart of water). After washing the terminals with this solution, wash the battery and surrounding area with clean water. When cleaning the battery always check the battery cap vent holes to make sure they are clear.

(3) **HANDLING THE BATTERY**

Exercise caution when handling the battery. Don't tip the battery or electrolyte may spill on your clothing. Do not set the battery on cement. Do not drop, pound or in any way subject the battery case to undue stress. Do not expose the battery to heat at any time.

(4) **BATTERY MAINTENANCE**

Check the battery electrolyte level frequently. Keep the battery full at all times. Over time, the battery electrolyte may evaporate reducing the battery's capacity to hold a charge and provide power for tractor starting and electrical system operation. If the electrolyte level is low add distilled water to the battery until the battery is full. The battery is full when the electrolyte is 3/8th of an inch above the plates. (See illustration below.)

MAINTENANCE



Each cell must be full for the battery to operate properly. Be careful when handling electrolyte. Electrolyte will eat holes in clothing, and when spilled on painted surfaces will remove paint and promote corrosion.

[NOTE]

A fully charged battery is protected from freezing down to -75°F while a discharged battery will freeze at 18°F .

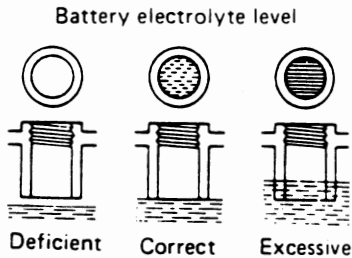

Keep the battery clean by wiping the top and sides of the battery case with a damp cloth. Do not allow corrosion to build up on battery terminals. To prevent corrosion build-up apply a solution of $\frac{1}{4}$ lb. of baking soda to 1 quart of water to the terminals. Be sure the battery caps are tight to prevent the solution from entering the cells.

After cleaning the battery, applying anti-corrosion solution to the terminals, or filling the battery, tighten all the caps and thoroughly flush the area around the battery with clean water.



[NOTE]

Since water and electrolyte do not mix immediately, do not add water to the battery in freezing weather unless the tractor is to be run for 2 to 3 hours to allow complete mixing of the water and electrolyte.

(5) CHECKING SPECIFIC GRAVITY

To check specific gravity, use a battery hydrometer. A fully charged battery has a specific gravity reading of 1.260. The battery must be charged if the hydrometer reading is below 1.215.

The hydrometer reading must be corrected for temperature. Add four gravity points (0.004) for every ten degrees of electrolyte temperature above 80 degrees F. Subtract four gravity points for every ten degrees below 80°F .

(6) COLD WEATHER BATTERY OPERATION

Your tractor battery may freeze in cold weather conditions if it is not kept full of electrolyte and fully charged. Cold weather has little effect on a fully-charged battery. Additionally, extra starting cranking power is needed when starting a cold engine in extremely cold weather conditions. To insure there is sufficient battery cranking power to start the engine, the battery must be full of electrolyte, fully charged and the terminals must be clean and making good contact with the battery cables.

(7) BATTERY REMOVAL AND INSTALLATION

To remove the battery, first disconnect the ground cable. Then disconnect the positive battery cable. Remove the battery hold-down clamp and lift the battery out.

Before installing the battery make sure both terminals are clean and there are no cracks in the battery case. Connect the positive cable first and tighten the clamp securely. Connect the negative terminal and secure the battery hold-down clamp. If any acid has been spilled, wash the battery and surrounding area thoroughly with clean water. Coat the terminals with the baking soda and water solution.



[CAUTION]

Kubota batteries are negative grounded only. Do not use a positive grounded battery in the tractor. Do not attempt to connect the positive cable to the negative pole on the battery. Reverse polarity can cause serious damage to the entire tractor electrical system. Connecting the negative terminal last will avoid the accidental occurrence of sparks which can cause battery explosion and burns.

(8) BATTERY STORAGE

If the tractor is to be stored for extensive periods of time (30 days or longer) remove the battery, fill the battery with electrolyte and charge the battery to a full charge. A battery is fully charged when the cells are all gassing freely (bubbles appear in each cell) and the specific gravity ceases to rise for three consecutive readings taken at hour intervals. Check and charge the battery every thirty days while in storage. Store the battery in a cool dry place but protect from freezing.

CHARGING TIMES FOR BATTERIES IN STORAGE

Period of storage from manufactured (months)	Recharging (times)
0-6	about 5 hours
6-12	10
over 12	30

(9) BATTERY CHARGING PROCEDURES

To charge the battery, remove all battery caps and check electrolyte level. Fill if necessary. Connect the battery to the charger, connect the positive cable first, then the negative cable. Charge the battery until fully recharged. A slow trickle charge is better than a quick charge.

SPECIFIC GRAVITY CHART

	AIR TEMPERATURES	
	TEMPERATURE Ordinarily below 68°F (20°C)	TROPICAL Frequently above 68°F (20°C)
sp. gr. of Electrolyte for Filling	1.260	1.240
sp. gr. of Electrolyte when fully charged	1.260 to 1.275	1.240 to 1.255

■ Alternator and voltage regulator

The alternator is located on the left-hand side of the engine and is powered by a belt turned by a pulley running off the front of the crankshaft. The alternator provides electrical current for charging the battery and for other electrical requirements of the tractor.

The voltage regulator is located on the firewall between the engine and fuel tank. The voltage regulator acts to control the voltage output of the alternator.

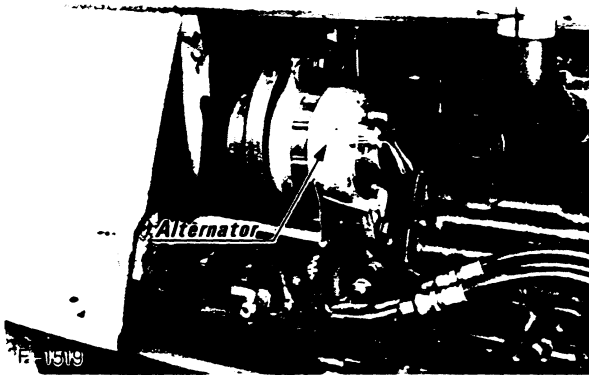

■ Alternator and voltage regulator servicing procedures

There are no service requirements for either the alternator or regulator; however, there are several precautions that should be observed while working on the electrical system.



- Always disconnect the batteries when working with or near the alternator or regulator.
- Be sure, in the event the voltage regulator or alternator wires are disconnected, that they be reconnected before connecting the battery cable back on the battery.
- Do not attempt to polarize an alternator.
- Do not ground alternator field circuit between the alternator and the regulator when the key is in the "ON" position or the engine is running.
- Do not ground the alternator output terminal or the circuit between the alternator and the battery.
- Do not operate the alternator on an open circuit; i.e. with the batteries disconnected or a broken wire between the battery and alternator.

■ Starter

The starter is located on the right-hand side of the engine. Under normal operating conditions the stater requires no maintenance. If the starter malfunctions, consult the trouble-shooting section of this manual or your KUBOTA Dealer.

In order that the starter operate properly, the battery must be fully charged. A malfunctioning starter can often be traced to a weak battery. If the starter will not turn the engine over, if there is a continuous clicking sound when the starter is engaged, check the battery charge before attempting to make repairs on the starter.

The starter is designed to operate under heavy loads for short periods of time. It is not advisable to operate the starter for more than 30 seconds of continuous operation. If, after several attempts, the engine will not start after 30 seconds of continuous starter engagement, consult the trouble-shooting section of this manual or your Kubota Dealer.

■ Fuses

The tractor electrical system is protected from potential damage by fuses. There are a total of seven fuses in the tractor electrical system. Six of the fuses are located in a fuse box on the firewall. The seventh fuse is an in-line fuse. Refer to the illustrations and chart below for the location of the fuses and fuse amperage.

Inoperative electrical components may indicate that a fuse has been blown. A blown fuse indicates that there is an overload or short somewhere in the electrical system.

MAINTENANCE

Before replacing a blown fuse, determine why the fuse blew and make any necessary repairs. Failure to follow this procedure may result in serious damage to the tractor electrical system. Refer to the trouble-shooting section of this manual or your Kubota dealer for specific information dealing with electrical problems.

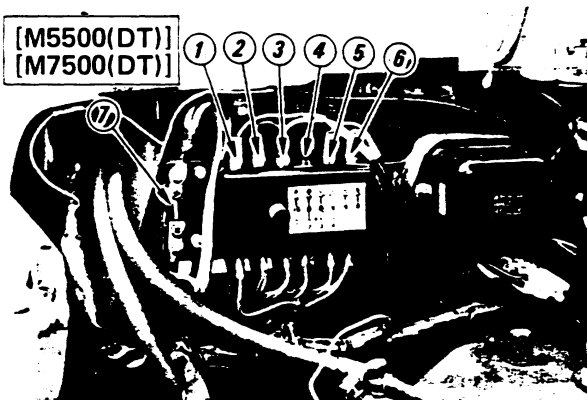
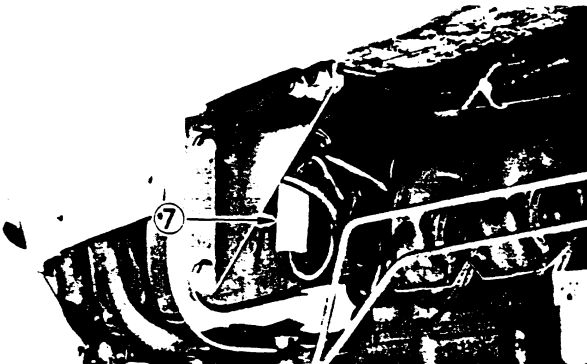
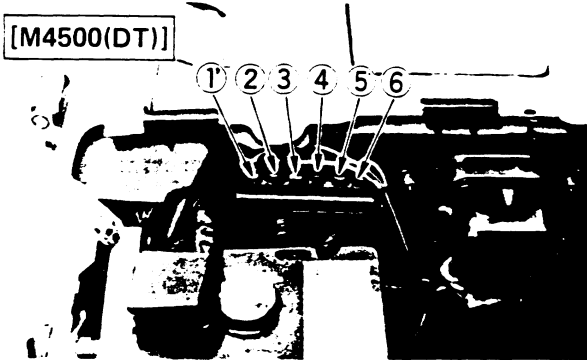

- | | |
|-----------------------|-----------------------|
| 1 Fuse 1 3amp. (3A) | 5 Fuse 5 8amp. (8A) |
| 2 Fuse 2 3amp. (3A) | 6 Fuse 6 8amp. (8A) |
| 3 Fuse 3 20amp. (20A) | 7 Fuse 7 60amp. (60A) |
| 4 Fuse 4 8amp. (8A) | |

■ Protected circuits

- (1) Fuse 1 Clearance lamps (optional)
- (2) Fuse 2 Fuel gauge, water thermometer, oil pressure pilot lamp, alternator warning lamp and PTO pilot lamp.
- (3) Fuse 3 Front and rear flasher,s flasher pilot lamps, radio and work lamp (Optional).
- (4) Fuse 4 Horn
- (5) Fuse 5 Head lamps (high beam), and illumination for control panel.
- (6) Fuse 6 Head lamps (lower beam)
- (7) Fuse 7 Check circuit against wrong battery connection.

10. FAN BELT ADJUSTMENT

Check the adjustment of the fan belt every time the engine oil is changed. When correctly adjusted the fan belt should have between 0.28 and 0.34 inches (7 to 9mm) of deflection in the middle of the longest span of the belt.

To adjust the fan belt tension, loosen the alternator mounting bolts and, using a lever placed between the alternator and the engine block, pull the alternator out until the deflection on the longest span of the belt falls within acceptable limits.

To replace the fan belt, loosen the alternator mounting bolts and move the alternator toward the engine block until the fan belt can be removed from the alternator pulley. With the belt removed from the alternator pulley, remove the belt from the crankshaft pulley and then slide the belt over the fan. It may be necessary to rotate the fan slightly to move the fan belt past the radiator fan shroud. To install a new belt, reverse this procedure.

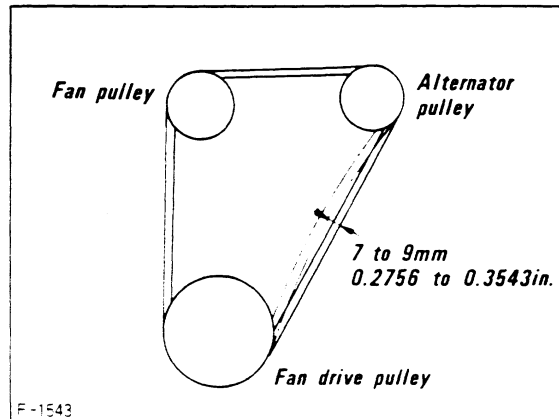

11. PERIODIC SERVICE SCHEDULE

Check every:	Service	Remarks
50 hours	Grease the brake pedal shaft (3 spots)	
	Grease the steering lever shaft (1 spot)	
	Grease the hydraulic power unit coupler section and the right lift rod (4 spots)	
	Grease the front wheel steering knuckle (2 spots) [Standard-types]	
	Grease the front axle support pipe (1 spot) [Standard-types]	
	Drain water in the fuel filter [M7500(DT)]	
150 hours	Check the clutch pedal free-play	Free-play should be between 1.2–1.6 in. (3–4cm)
	Check the brake pedal free-play	Free-play should be between 1.4 – 1.8 in. (3.5 – 4.5cm)[M4500 (DT)] 1.6 – 2.0 in. (4 – 5cm) [M5500 (DT) · M7500 (DT)]
	Check the PTO clutch control lever free-play	Free-play should be between 1.6–2.0 in. (4–5cm)
	Check the battery electrolyte level	
	Change engine oil [M4500 (DT)]	Engine oil CD (DS) : 13.4 qts. (12.7ℓ)
	Replace oil filter (2) elements [M4500 (DT)]	
	Check the Toe-in	
	Check to see if the radiator hose band are slack	
200 hours	Change engine oil [M5500(DT)·M7500(DT)]	Engine oil CD (DS) M5500 (DT) : 10.4 qts. (9.8ℓ) M7500 (DT) : 12.5 qts. (11.8ℓ)
	Grease the clutch release bearing (1 spot)	
	Clean the fuel pump [M5500 (DT) · M7500 (DT)]	
	Check the fan belt tension. Adjust as necessary	
	Clean hydraulic oil strainer and magnetic filter	
400 hours	Replace fuel filter (1) elements [M5500 (DT) · M7500 (DT)]	
	Check the steering box oil level	
	Replace oil filter cartridges [M5500 (DT) · M7500 (DT)]	
	Replace fuel filter cartridges [M4500 (DT)]	
	Change power steering oil	
600 hours	Grease the front wheel hub bearings [Standard-types]	
	Change transmission oil for hydraulic unit	SAE 80 wt. gear oil 47.6 qts. (45ℓ)
	Change oil in the right and left front axle cases [DT-types]	SAE 80 wt. gear oil 3.7 qts. (3.5ℓ)
	Change oil in the front differential gear case [DT-types]	SAE 80 wt. gear oil 3.7 qts. (3.5ℓ)
800 hours	Change oil in the right and left front bevel gear cases [DT-types]	SAE 80 wt. gear oil 0.8 qt. (0.8ℓ)
	Remove sediment in the fuel tank	
	Replace fuel filter (2) element [M7500(DT)]	
	Clean the cooling system	Flush with commercial radiator cleaner and clear water
	Check the valve clearance [M5500 (DT) · M7500 (DT)]	Ask your Kubota dealer to check it
	Check the fuel injection pressure of the nozzle [M5500 (DT) · M7500 (DT)]	

MAINTENANCE

12. BATTERY TROUBLE SHOOTING

Trouble	Cause	Corrective Measure	Preventive Measure
Starter will not engage.	Light have been left on.	Recharge the battery with battery charger.	Charge battery. Keep battery fully charged.
	Battery has not been charged.		
	Poor battery terminal connection.	Clean the battery terminals and tighten cable clamps.	Keep terminals clean and cable clamps tight. Apply anticorrosives to terminals.
	Battery is dead.	Replace the battery.	
Starter will not engage. Battery has been charged.	Insufficient charging.	Recharge the battery with slow trickle charge.	Give battery full charge before operating tractor.
Battery cell plates appear white in color.	Battery electrolyte level low.	Add distilled water and charge the battery.	Make frequent checks of battery electrolyte level.
	Battery discharged.	Recharge the battery.	Keep battery fully charged.
Battery will not take charge.	Battery is dead.	Replace the battery.	
Terminals are corroded and heat up.	Poor battery terminal connection.	Clean the terminals and tighten the cable clamps.	Keep terminals clean and cable clamps tight.
Battery electrolyte level drops rapidly after filling.	Crack or small hole in battery case.	Replace battery.	Tighten battery hold down clamp.

13. ENGINE TROUBLE SHOOTING

Trouble	Cause	Corrective Measures
Engine is difficult to start.	Blockage in fuel system.	(1) Check the fuel tank. Clean out trapped sediment. (2) Blocked fuel filter. Replace the fuel filter.
	Air and water in fuel system.	(1) Check tightness of fuel line fittings. (2) Bleed the fuel system to remove trapped air.
	Crankcase oil too heavy for prevailing temperature conditions.	(1) Pour hot water over radiator. (2) See lubrication section of this manual for correct oil for use in temperature range in which tractor will be operated.
	Battery lacks the power to turn engine over.	(1) Charge the battery. (2) Use engine decompression device. (3) During winter months and other times of intermittent use remove the battery from the tractor, charge and store indoors. Reinstall the battery in the tractor only when the tractor is to be used.
Engine lacks power.	Blockage in fuel system.	(1) Check the fuel system – Remove trapped sediment, air or water.
	Air cleaner clogged.	(1) Clean air filter element.
Engine stops suddenly.	Fuel tank low on fuel.	(1) Refuel – Bleed fuel system if fuel tank has been emptied.
	Blockage in fuel system.	(1) Check the fuel system – Remove trapped sediment air or water.
Exhaust smoke wrong color.	Poor quality fuel.	(1) Change to higher quality fuel.

STORAGE

1. TRACTOR STORAGE

If you intend to store your tractor for an extended period of time, follow the procedures outlined below. These procedures will insure that the tractor is ready to operate with minimum preparation or refurbishing when it is removed from storage.

- (1) Store the tractor indoor in a dry area that is protected from sunlight and excessive heat. If the tractor must be stored outdoors, cover it with a waterproof tarp.
- (2) Change the engine crankcase oil and oil filter. Used crankcase oil will not protect internal engine parts from rust.
- (3) Drain and flush the cooling system. Refill the system with a solution of water and anti-freeze.
- (4) Clean the engine air filter.
- (5) Run the engine to circulate oil and coolant throughout the engine block and internal moving parts.
- (6) Fill the fuel tank with fuel.
- (7) Close fuel tank petcock.
- (8) Remove the battery from the tractor. Store the battery following the battery storage procedures outlined in the maintenance section of this manual.
- (9) Seal the following with heavy gauge plastic and adhesive tape: The air cleaner inlet, exhaust outlet, radiator overflow tube and engine breather cap.
- (10) With all implements lowered to the ground, coat any exposed hydraulic cylinder piston rods with grease.
- (11) Paint exposed metal surfaces to protect them from corrosion.
- (12)  Jack the tractor up and place blocks under the front and rear axle so that all four tires are off the ground. Keep the tires out of direct sunlight and extreme heat.
- (13) Hold the clutch pedal in the disengaged position by placing a block between the clutch pedal lever and the step plate.

2. REMOVING THE TRACTOR FROM STORAGE

- (1) Check the tire air pressure and inflate the tires if they are low.
- (2) Jack the tractor up and remove the support blocks from under the front and rear axle.
- (3) Remove the protective plastic and coverings from the air cleaner, exhaust pipe, radiator overflow tube and engine breather cap.
- (4) Install the battery. Before installing the battery, be sure it is fully charged.
- (5) Check the fan belt tension.
- (6) Check all fluid levels (engine oil, transmission/hydraulic oil, engine coolant and any attached implements.)
- (7) Open the fuel petcock.
- (8) Remove the block between the clutch pedal shaft and the step plate.
- (9) Start the engine. Observe all gauges. If all gauges are functioning properly and reading normal, move the tractor outside. Once outside, park the tractor and let the engine run at an idle for at least five minutes. While the engine is warming up, walk around the tractor and make a visual inspection looking for evidence of oil or water leaks.
- (10) With the engine fully warmed up, release the parking brake and test the brakes for proper adjustment as you move forward. Adjust the brakes as necessary.

SPECIFICATIONS

1. SPECIFICATIONS	43
2. TRACTOR SPEED	45

SPECIFICATIONS

1. SPECIFICATIONS

Model		M4500	M4500DT	
Engine	Model	S2600-A		
	Type	Vertical, water-cooled, 4-cycle diesel engine		
	Number of cylinders	6		
	Total displacement	158.5 Cu.in. (2598cm ³)		
	Bore and stroke	3-15/64 x 3-15/64 in. (82 x 82mm)		
	Maximum output	Bare 55.5 HP (41.4 kW)/2600 rpm (43.3 r/s)		
	Maximum output (PTO)	*49 HP (36.55 kW)		
	Maximum torque	117.6 ft.lbs. (16.2 kgf·m; 158 N·m)/1400 rpm (23.3 r/s)		
	Battery capacity	G160-10 [Dry, 12V 150AH (110Ah-20HR)]		
	Fuel	No. 2 diesel fuel		
	Fuel tank capacity	14.3 Gallons (54ℓ)		
	Engine oil tank capacity	13.42 Quarts (12.7ℓ)		
	Cooling system capacity	8.9 Quarts (8.4ℓ)		
Dimensions	Overall length	132-1/2 in. (3365mm)	137-5/8 in. (3495mm)	
	Overall width	66-3/8 in. (1685mm)	70-1/4 in. (1785mm)	
	Overall height	89 in. (2260mm)	90-1/8 in. (2290mm)	
	Wheel base	78-1/8 in. (1985mm)	79-1/2 in. (2020mm)	
	Tread	Front	50-3/8~78 in. (1280~1980mm)	55-7/8 in. (1420mm)
		Rear	51-3/16 ~ 74-13/16 in. (1300 ~ 1900mm)	
	Minimum ground clearance	15-1/2 in. (395mm)	12-3/8 in. (315mm)	
Weight	4232.8 lbs. (1920kg)	4850 lbs. (2200kg)		
Travelling system	Tire size	Front tires	6.00-16-6PR (AG) 8.3/8-24-6PR (AG)	
		Rear tires	14.9/13-28-6PR(AG)	
	Clutch	Single dry plate, double type		
	Steering	Ball screw		
	Braking system	Single system, independent, wet type disc brake		
Differential system	Bevel gears (differential lock)			
Hydraulic unit	Hydraulic control system	Position control, draft control and mixed control		
	Pump-up capacity	7.3 Gallons/min. (27.5 ℓ/min)		
	Three-point hitch	Category 1 & 2		
	Maximum lifting force	3300 lbs. (1500 kg)		
Traction system		Swing drawbar adjusts height and direction		
PTO shaft	Live PTO	Direction of turning	Clockwise, viewed from tractor rear	
		Standard PTO	540 rpm (9 r/s)/2193 rpm (36.6 r/s) for engine	
	Ground PTO	Direction of turning	Clockwise, viewed from tractor rear	
		PTO speed	1.59 turns/m (with 14.9-28 tires)	

M5500		M5500DT		M7500		M7500DT	
D3000-A				V4000-A			
Vertical, water-cooled, 4-cycle diesel engine				Vertical, water-cooled, 4-cycle diesel engine			
3				4			
182.2 Cu. in. (2987 cc)				243 Cu. in. (3983 cc)			
4-9/64 x 4-17/32 in. (105 x 115mm)				4-9/64 x 4-17/32 in. (105 x 115mm)			
Bare 63 HP (47 kW)/2400 rpm				Bare 81 HP (60.4 kW)/2400 rpm			
*53.9 HP (40.2 kW)				*72 HP (53.71 kW)			
150.3 ft. lbs. (20.8 kgf-m; 204 N-m)/1400 rpm				201.7 ft. lbs. (27.9 kgf-m; 273 N-m)/1400 rpm			
NX300-15 (Dry; 12V 300AH)				NX300-15 (Dry; 12V 300 AH)			
No. 2 diesel fuel				No. 2 diesel fuel			
14.3 Gallons (54ℓ)				14.3 Gallons (54ℓ)			
10.4 Quarts (9.8ℓ)				12.5 Quarts (11.8ℓ)			
12.3 Quarts (11.6ℓ)				13.8 Quarts (13ℓ)			
132-5/8 in. (3370mm)	139 in. (3530mm)	142-7/8 in. (3630mm)	147-7/8 in. (3755mm)				
66-3/8 in. (1685mm)	70-5/8 in. (1795mm)	71-1/4 in. (1810mm)	72 in. (1830mm)				
87-3/16 in. (2215mm)	88-3/4 in. (2255mm)	89-1/8 in. (2265mm)	89-1/8 in. (2265mm)				
79-7/8 in. (2030mm)	80-7/8 in. (2055mm)	84-7/8 in. (2155mm)	85-5/8 in. (2175mm)				
50-3/8~78 in. (1280~1980mm)	55-7/8 in. (1420mm)	53-7/8 ~ 77-1/2 in. (1370 ~ 1970mm)	57-7/8 in. (1470mm)				
51-3/16 ~ 74-13/16 in. (1300 ~ 1900mm)				55-1/8 ~ 74-13/16 in. (1400 ~ 1900mm)			
15 in. (380mm)	12-3/8 in. (315mm) (at the bottom of front axle)	18-1/4 in. (465mm)	13-3/8 in. (340mm) (at the bottom of front axle)				
4629.7 lbs. (2100kg)	5114.7 lbs. (2320kg)	4916 lbs. (2230kg)	5666 lbs. (2570kg)				
6.00-16-6PR (AG)	8.3/8-24-6PR (AG)	7.50-16-6PR	9.5/9-24-6PR (AG)				
14.9/13-28-6PR (AG)				16.9/14-30-6PR (AG)			
Single dry plate, double type				Single dry plate, double type			
Ball screw				Ball screw			
Single system, independent, wet type disc brake				Single system, independent, wet type disc brake			
Bevel gears (differential lock)				Bevel gears (differential lock)			
Position control, draft control and mixed control				Position control, draft control and mixed control			
8.06 Gallons/min. (30.5ℓ/min.)				8.06 Gallons/min. (30.5ℓ/min.)			
Category 1 & 2				Category 1 & 2			
3300 lbs. (1500 kg) (at the end of bottom links)				3300 lbs. (1500 kg) (at the end of bottom links)			
Swinging drawbar adjusts height and direction				Swinging drawbar adjusts height and direction			
Clockwise, viewed from tractor rear				Clockwise, viewed from tractor rear			
540 rpm (2016 rpm for engine)				540 rpm (2016 rpm for engine)			
Clockwise, viewed from tractor rear				Clockwise, viewed from tractor rear			
1.55 turns/m (with 14.9 - 28 tires)				1.51 turns/m (with 16.9 - 30 tires)			

*Maximum P.T.O. horse power in Official Test.

2. TRACTOR SPEED

MODEL			M4500 (DT)		M5500 (DT)		M7500 (DT)	
At rear tires			14.9/13-28		14.9/13-28		16.9/14-30	
Creep lever	H-L lever	Main lever	Speed		Speed		Speed	
			mph	km/h	mph	km/h	mph	km/h
L Do not two when using creep gears	L	1	0.26	0.42	0.27	0.43	0.28	0.45
		2	0.32	0.51	0.33	0.52	0.34	0.55
		3	0.53	0.86	0.55	0.88	0.58	0.92
		4	0.73	1.17	0.76	1.21	0.78	1.25
		R	0.34	0.55	0.36	0.57	0.37	0.59
	H	1	0.97	1.56	1.00	1.61	1.05	1.68
		2	1.18	1.90	1.23	1.96	1.28	2.04
		3	1.99	3.20	2.06	3.30	2.14	3.43
		4	2.72	4.37	2.72	4.35	2.93	4.69
		R	1.27	2.05	1.33	2.12	1.38	2.20
H	L	1	1.50	2.43	1.56	2.5	1.63	2.6
		2	1.84	2.96	1.94	3.1	2.00	3.2
		3	3.09	4.97	3.19	5.1	3.31	5.3
		4	4.23	6.80	4.38	7.0	4.56	7.3
		R	1.98	3.19	2.06	3.3	2.13	3.4
	H	1	5.64	9.08	5.88	9.4	6.06	9.7
		2	6.87	11.05	7.13	11.4	7.44	11.9
		3	11.56	18.61	12.00	19.2	12.5	20.0
		4	15.80	25.42	16.40	26.2	17.1	27.3
		R	7.42	11.94	7.68	12.3	8.00	12.8

